

COLLEZIONE

MODO PROJECT_MANIGLIA

altamarea®

BATHROOM
BOUTIQUE

MELAMINICO/TECNOMATT

Finiture
Finishes
Finition
Acabados

MODO
~~LYMPHA~~
~~LYMPHA-MONILITE~~
~~360 GRADI~~
~~OPERA~~
~~MUST~~

MELAMINICO/TECNOMATT

MELAMINE/TECNOMATT - - MÉLAMINÉ/TECNOMATT - - MELAMINICO/TECNOMATT

Effetto Calce

Cement effect • Effet mur • efecto cal



Calce 73

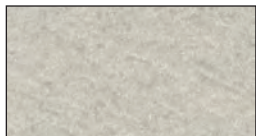

Calce 45

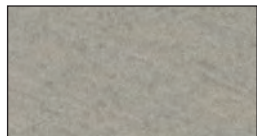

Calce 51

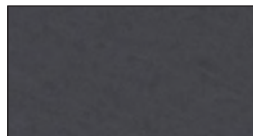

Calce 08

Effetto legno

Wood effect • Effet bois • efecto madera



Columbia 22



Chamonix 22



Noce Light



Gobin



Rovere Fanes



Maui

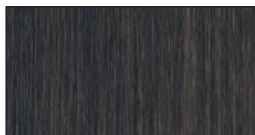

Moro

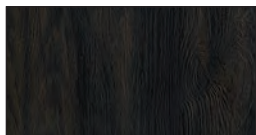

Smoke

Effetto tinta unita

Plain color effect • couleur unie • efecto monocolor



Polar

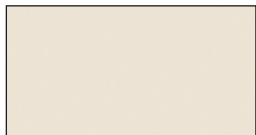

Seta 22



Dolphin 22



Bruma 22

Tecnomatt

Tecnomatt • Tecnomatt • Tecnomatt



Fumo Matt



Verde Timo

▲ **Non disponibile per elementi a giorno e top**
Not available for open shelf units and tops
Non disponibles pour éléments meubles ouverts et plans
No disponible para elementos abiertos y encimeras

N.B. Attenzione colori indicativi, consultare mazzetta campioni finiture.

NOTE: Colours are indicative, please refer to the finish samples

Attention : les photos des couleurs sont indicatives, vérifiez le bon coloris dans les échantillons

N.B.: Atención colores orientativos, consultar muestrario de acabados.

LAMINATO HPL

Finiture
Finishes
Finition
Acabados

MODO
LYMPHA
LYMPHA-MONILITE
360 GRADI
360 GRADI+
OPERA
MUST

LAMINATO HPL

HPL LAMINATE - - STRATIFIÉ HPL - - LAMINADO HPL

Effetto legno

Wood effect • Effet bois • efecto madera



Rovere Wafer



Quercia Grigia



Rovere Monet



Noce Savoia



Rovere Bruciato

Effetto malta

Resin effect (mortar) • Effet beton • efecto cemento



Malta Bianca



Malta Grigia



Malta Canapa

Effetto pietra

Stone effect • Effet pierre • efecto piedra



Piasentina



Pietra Lavica



Nocturne

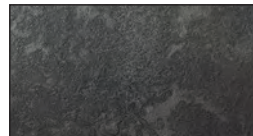

Cesar Brown Stone

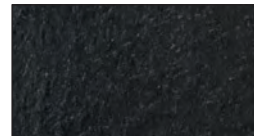

Nero Tecno

N.B. Attenzione colori indicativi, consultare mazzetta campioni finiture.

NOTE: Colours are indicative, please refer to the finish samples

Attention : les photos des coloris sont indicatifs, vérifiez le bon coloris dans les échantillons

N.B.: Atención colores orientativos, consultar muestrario de acabados.

FENIX NTM®

Finiture
Finishes
Finition
Acabados

MODO
LYMPHA
LYMPHA_MONOLITE
360 GRADI
360 GRADI +
OPERA
MUST

FENIX NTM®

FENIX NTM® - - FENIX NTM® - - FENIX NTM®

F1



Bianco Kos



Grigio Londra



Nero Ingo

F2

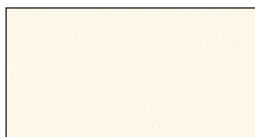

Bianco Malè



Beige Arizona



Castoro Ottawa

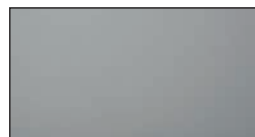

Grigio Antrim



Grigio Bromo



Verde Comodoro



Rosso Jaipur



Grigio Aragona



Blu Shaba

N.B. Attenzione colori indicativi, consultare mazzetta campioni finiture.

NOTE: Colours are indicative, please refer to the finish samples

Attention : les photos des coloris sont indicatifs, vérifiez le bon coloris dans les échantillons

N.B.: Atención colores orientativos, consultar muestrario de acabados.

LACCATO

Finiture
Finishes
Finition
Acabados

MODO
LYMPHA
LYMPHA_MONOLITE
360 GRADI
360 GRADI +
OPERA
MUST

LACCATO
LACQUERED - - LAQUÉ - - LACADO

Ossidato
Ossidato • Oxydé • Oxidado

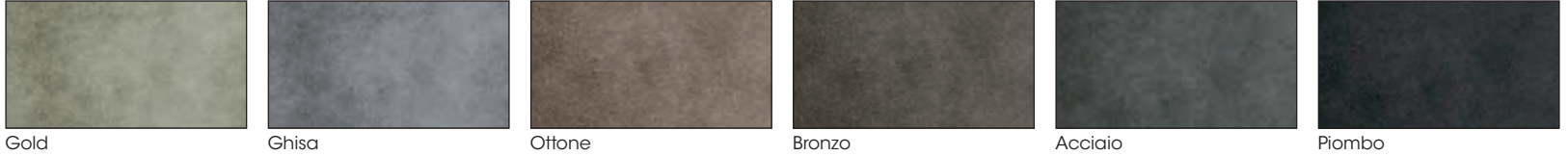

Sand / Lucido
Sand / High gloss • Sand / Brillant • mate/brillo

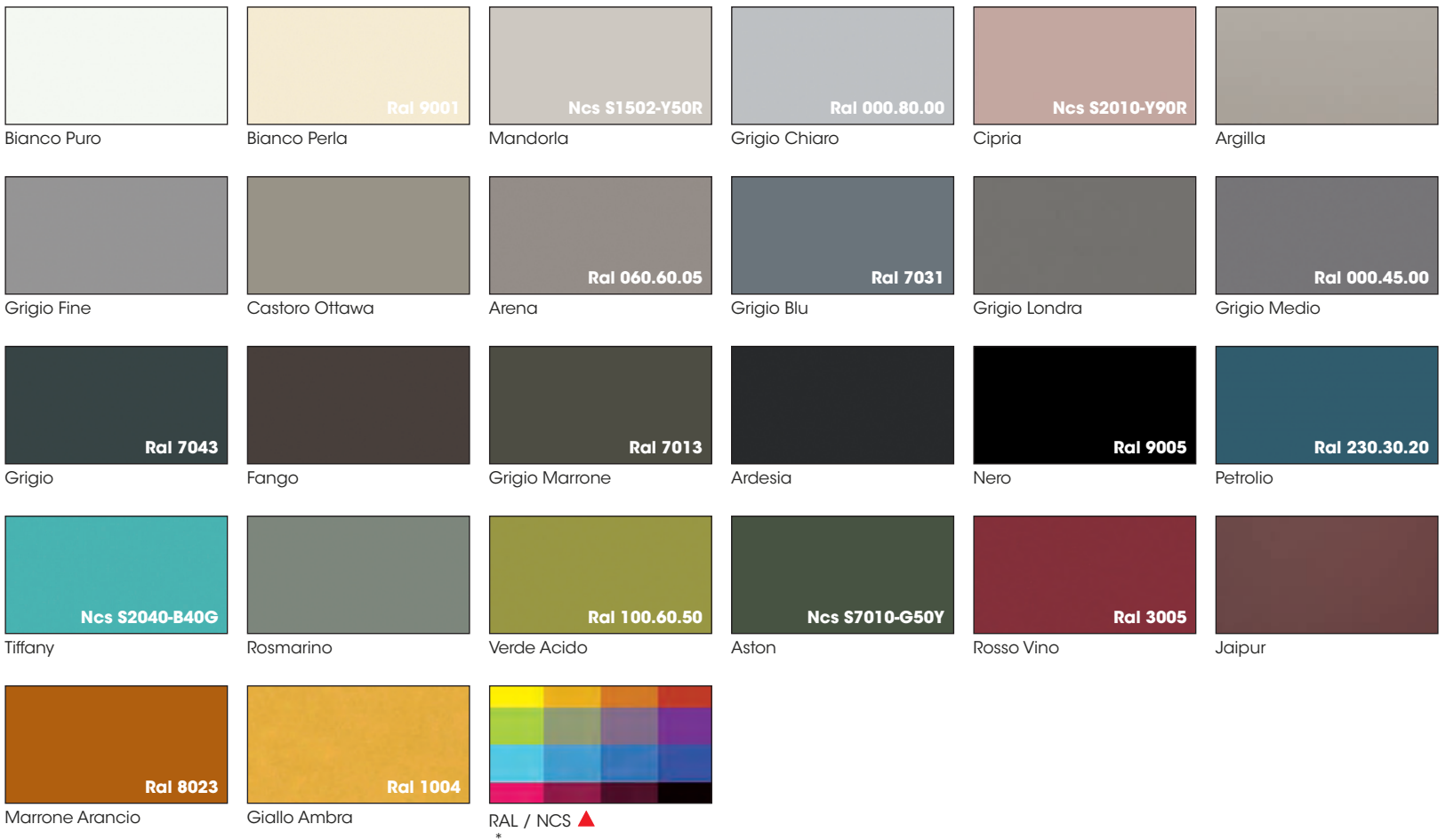

▲ Per laccato a riferimento RAL o NCS addebito di € 150,00 per colore
The surcharge for RAL or NCS laquered colours is € 150,00 for each colour
Pour la laque RAL ou NCS rajouter € 150,00 euros par couleur.
Para lacados RAL o NCS sobreprecio de € 150,00 por color

N.B. Attenzione colori indicativi, consultare mazzetta campioni finiture.
NOTE: Colours are indicative, please refer to the finish samples
Attention : les photos des coloris sont indicatifs, vérifiez le bon coloris dans les échantillons
N.B.: Atención colores orientativos, consultar muestrario de acabados.

ROVERE

Finiture

Finishes

Finition

Acabados

MODO
LYMPHA
LYMPHA_MONOLITE
360 GRADI
360 GRADI +
OPERA
MUST

ROVERE VENATURA VERTICALE

OAK - VERTICAL GRAIN - CHÊNE - VEINAGE VERTICAL - ROBLE VETA VERTICAL



Rovere Laccato Bianco



Rovere Chiaro



Rovere Tostato



Rovere Atlas



Rovere Cacao

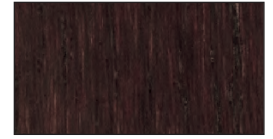

Rovere Scuro



Rovere Savana



Rovere Laccato Nero

USO E MANUTENZIONE

USE AND MAINTENANCE

AVERTISSEMENTS D'UTILISATION ET MAIN-

TENANCE

ADVERTENCIAS DE USO Y MANUTENCIÓN

N.B. Attenzione colori indicativi, consultare mazzetta campioni finiture.

NOTE: Colours are indicative, please refer to the finish samples

Attention : les photos des couleurs sont indicatives, vérifiez le bon coloris dans les échantillons

N.B.: Atención colores orientativos, consultar muestrario de acabados.

TRACCIA VENATURA VERTICALE

TRACCIA - VERTICAL GRAIN - TRACCIA - VEINAGE VERTICAL - TRACCIA VETA VERTICAL

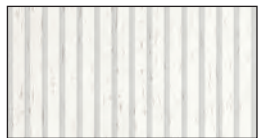

Rovere Laccato Bianco



Rovere Chiaro



Rovere Tostato



Rovere Atlas



Rovere Cacao

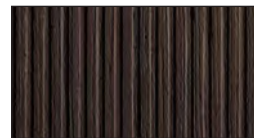

Rovere Scuro

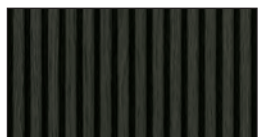

Rovere Savana



Rovere Laccato Nero

▲ **Disponibile solo su ante e fianchi Sp. 2,2 cm**

Only available on doors and side panels th.2,2cm

Disponibile uniquement pour portes et joues en ép.2,2 cm

Disponibile solo en puertas y laterales de 2,2 cm de grosor

N.B. Attenzione colori indicativi, consultare mazzetta campioni finiture.

NOTE: Colours are indicative, please refer to the finish samples

Attention : les photos des coloris sont indicatifs, vérifiez le bon coloris dans les échantillons

N.B.: Atención colores orientativos, consultar muestrario de acabados.

ESSENZE

Finiture
Finishes
Finition
Acabados

MODO
LYMPHA
LYMPHA_MONOLITE
360 GRADI
360 GRADI +
OPERA
MUST

ESSENZE VENATURA VERTICALE

VENEERED WOODEN FINISHES - VERTICAL GRAIN - FINITIONS BOIS - VEINAGE VERTICAL - ACABADOS MADERA VETA VERTICAL



Sabbiato Amalfi



Olmo Naturale



Rovere Nodino Chiaro

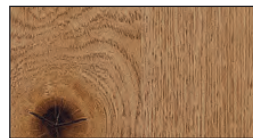

Rovere Nodino Tostato



Olmo Termocotto

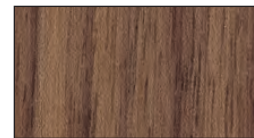

Noce Canaletto



Sabbiato Cortina

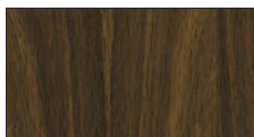

Rovere Termocotto



Eucalipto Termocotto

N.B. Attenzione colori indicativi, consultare mazzetta campioni finiture.

NOTE: Colours are indicative, please refer to the finish samples

Attention : les photos des coloris sont indicatifs, vérifiez le bon coloris dans les échantillons

N.B.: Atención colores orientativos, consultar muestrario de acabados.

MODO PROJECT_MANIGLIA

Informazioni tecniche

Technical information
Informations techniques
Notas técnicas

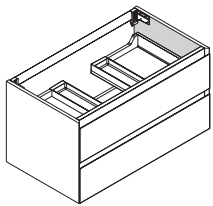

BASE REGGILAVABO SOSPESA

Frontali Sp. 2,2 cm
 • Melaminico/Tecnomatt
 • Laccato Sand / Lucido / Ossidato
 • Fenix NTM® / Laminato
 • Rovere / Essenze
 • Traccia (solo frontali, fianchi in Rovere)

Scocca
 • Pannello melaminico sp. 1,8 cm finitura bianco o grafite

Disponibile con maniglia esterna o maniglia integrata Groove

Attaccaglie in acciaio regolabili con barra di rinforzo in alluminio, portata max 120 kg.

HANGING WASHBASIN UNIT

Front panels th. 2,2 cm.
 • Melamine/Tecnomatt
 • Sand lacquered / Glossy / Oxidised
 • Fenix NTM® / Laminate
 • Oak / Woods
 • Traccia
 Visible side panels (Included in the price)

Carcase
 • 1,8 cm thick melamine panel white or graphite

Available with external handle or Groove integrated handle

St. Steel adjustable brackets with aluminum reinforcement bar. Maximum loading capacity 120 kg.

BAS POUR LAVABO SUSPENDU

Façades de 2,2 cm d'épaisseur
 • Mèlaminé/Tecnomatt
 • Laqué Sand / brillant / oxydé
 • Fenix NTM® / Stratifié
 • Chêne / Bois
 • Traccia
 Côtés visibles (inclus dans le prix)

Caisson
 • Panneau mélaminé ép. 1,8 cm finition blanc ou graphite

Disponibile avec poignée externe ou poignée intégrée Groove

Accroches en acier réglables avec barre de renfort en aluminium, portée max. 120 kg.

MUEBLE PARA LAVABO COLGANTE

Frentes de 2,2 cm
 • Melaminico/Tecnomatt
 • Lacado Sand / brillo / oxidado
 • Fenix NTM® / Laminado
 • Roble / Maderas
 • Traccia
 Lados vistos (incluidos en el precio)

Bastidor
 • Panel en melamina esp. 1,8 cm acabado blanco o grafite

Disponibile con tirador exterior o con el tirador Groove integrado

Soportes en acero ajustables con barra de refuerzo en aluminio, capacidad max. 120 kg

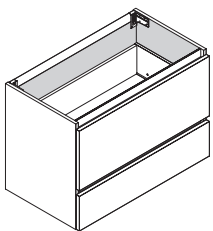

BASE ARREDO SOSPESA

Materiali, finiture e maniglie come base reggilavabo sospesa
 • Schiena in finitura bianco o grafite sp. 0,5 cm

Attaccaglie in acciaio regolabili con barra di rinforzo in alluminio, portata max 120 kg.

WALL HANGING BASE UNIT

Materials and finishes are the same as the suspended washbasin units
 • 0,5 cm thick back panel white or graphite

St. Steel adjustable brackets with aluminum reinforcement bar. Maximum loading capacity 120 kg.

MEUBLE BAS SUSPENDU

Matériaux et finitions comme pour bas porte-vasque suspendu
 • Dos en finition blanc ou graphite ép. 0,5 cm

Accroches en acier réglables avec barre de renfort en aluminium, portée max. 120 kg.

MUEBLE BASE COLGANTE

Materiales y acabados como mueble para lavabo
 • Trasera en acabado blanco o grafite esp. 0,5 cm

Soportes en acero ajustables con barra de refuerzo en aluminio, capacidad max. 120 kg

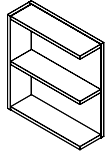
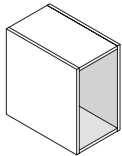

BASE JOLLY A GIORNO

• Scocca in pannello sp. 1,8 cm in tutte le finiture dei frontali
 • Schiena in pannello sp. 1 cm in tutte le finiture dei frontali

Attaccaglie a scomparsa con regolazione dall'interno

JOLLY OPEN SHLED BASE UNIT

• 1,8 cm thick carcasse panel available in all finishes of door's fronts
 • 1 cm thick back panel available in all finishes

Concealed and adjustable wall supports

BAS OUVERT JOLLY

• Caisson en panneau ép. 1,8 cm dans toutes les finitions des façades
 • Dos en panneau ép. 1 cm dans toutes les finitions des façades

Accroches rétractables avec réglage de l'intérieur

BASE JOLLY ABIERTA

• Bastidor en panel esp. 1,8 cm en todos los acabados de los frentes
 • Trasera en panel esp. 1 cm en todos los acabados de los frentes

Soportes ocultos que se ajustan desde el interior

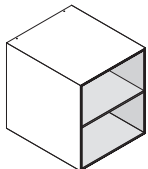

ELEMENTI A GIORNO

• Scocca in pannello Sp. 1 cm in tutte le finiture dei frontali
 • Schiena in pannello sp. 1 cm in tutte le finiture dei frontali

Attaccaglie a scomparsa regolabili dall'alto

OPEN SHELF UNITS

• 1 cm thick carcasse panel available in all finishes of door's fronts
 • 1 cm thick back panel available in all finishes

Concealed and adjustable brackets

MEUBLES OUVERTS

• Caisson fabriqué avec panneaux ép. 1 cm dans toutes les finitions en gamme pour les façades
 • Dos en panneau ép. 1 cm dans toutes les finitions des façades

Accroches rétractables réglables depuis le haut

ELEMENTOS ABIERTOS

• casco en panel de 1 cm de grosor en todos los acabados de frente
 • Trasera en panel esp. 1 cm en todos los acabados de los frentes

Soportes ocultos ajustable por arriba

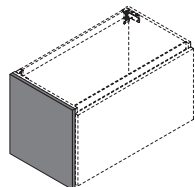

FIANCO A RIDOSSO (su richiesta vedi pag. 94)

• Pannello sp. 1 cm o 2,2 cm da affiancare al mobile disponibile in tutte le finiture dei frontali
 • Traccia (solo fianchi Sp. 2,2 cm)

ADDITIONAL SIDE PANEL (on request, please refer to page 94)

• 1 or 2,2 cm thick additional side panel, available in all finishes of the door's fronts
 • Traccia (only side panels th.2,2cm)

JOUE EN SURÉPAISSEUR (sur demande voir page 94)

• Panneau ép. 1 cm et 2,2 cm à positionner à côté du meuble
 • Traccia (joints uniquement en ép. 2,2 cm)

COSTADO SOBREPUESTO (bajo pedido ver pag 94)

• Panel esp. 1 cm o 2,2 cm por acostar al mueble disponible en todos los acabados de los frentes
 • Traccia (solo costados de 2,2 cm de grosor)

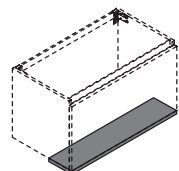

FASCIA INFERIORE (su richiesta vedi pag. 94)

• Pannello estetico sp. 1 cm da fissare sul lato inferiore del mobile disponibile in tutte le finiture dei frontali

Lower strip panel (upon request, see page 94)

• 1 cm thick back to be applied underneath the cabinets, available in all finishes

Profil inférieur (sur demande voir page 94)

• Panneau esthétique ép. 1 cm à fixer sur le côté inférieur du meuble disponible dans toutes les finitions des façades

Tapeta inferior (bajo pedido ver pag 94)

• Tapeta de cierre inferior estética esp. 1 cm por sujetar en la parte abajo del mueble disponible en todos los acabados de los frentes

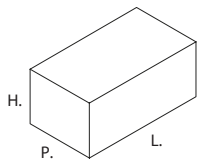

BASE REGGILAVABO
WASHBASIN UNITS
MEUBLE PAS PORTE-VASQUE
MUEBLES LAVABOS

H. 18

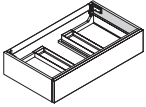

P. 36.7 - 45.5 - 51
L. 60 - 75 - 90 - 105 - 120
- 135

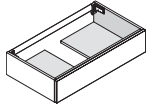

P. 36.7 - 45.5 - 51
L. 60 - 75 - 90 - 105 - 120
- 135

H. 24

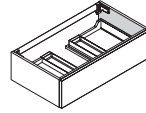

P. 36.7 - 45.5 - 51
L. 60 - 75 - 90 - 105 - 120
- 135

H. 39,5

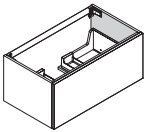

P. 36.7 - 45.5 - 51
L. 60 - 75 - 90 - 105 - 120
- 135

H. 48

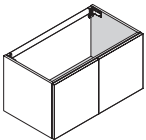

P. 36.7 - 45.5 - 51
L. 60 - 75 - 90 - 105 - 120

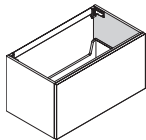

P. 36.7 - 45.5 - 51
L. 60 - 75 - 90 - 105 - 120
- 135

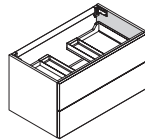

P. 36.7 - 45.5 - 51
L. 60 - 75 - 90 - 105 - 120
- 135

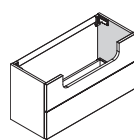

P. 36.7
L. 75 - 90 - 105 - 120 - 135

H. 60

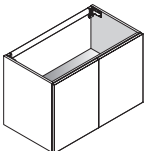

P. 36.7 - 45.5 - 51
L. 60 - 75 - 90 - 105 - 120

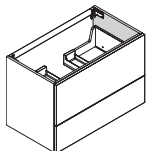

P. 36.7 - 45.5 - 51
L. 60 - 75 - 90 - 105 - 120
- 135

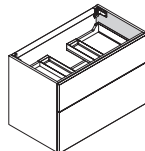

P. 36.7 - 45.5 - 51
L. 60 - 75 - 90 - 105 - 120
- 135

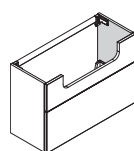

P. 36.7
L. 75 - 90 - 105 - 120 - 135

H. 79

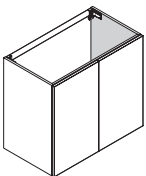

P. 36.7 - 45.5 - 51
L. 60 - 75 - 90 - 105 - 120

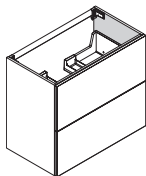

P. 36.7 - 45.5 - 51
L. 60 - 75 - 90 - 105 - 120
- 135

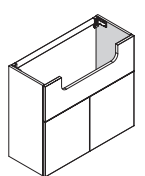

P. 36.7
L. 90 - 120

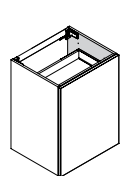

P. 51
L. 60 - 75

MODO PROJECT_MANIGLIA

Modularità
Modularity
Modularité
Modularidad

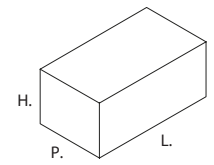

BASE ARREDO
UNIT BASE
ÉLÉMENT BAS
MUEBLE BAJO

H. 18

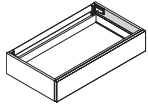

P. 36.7 - 45.5 - 51
L. 30 - 45 - 60 - 75 - 90 -
105 - 120 - 135

H. 24

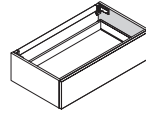

P. 36.7 - 45.5 - 51
L. 30 - 45 - 60 - 75 - 90 -
105 - 120 - 135

H. 39,5

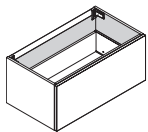

P. 36.7 - 45.5 - 51
L. 30 - 45 - 60 - 75 - 90 -
105 - 120 - 135

H. 48

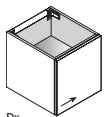

P. 36.7 - 45.5 - 51
L. 30 - 45

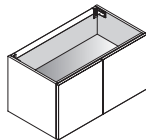

P. 36.7 - 45.5 - 51
L. 60 - 75 - 90 - 105 - 120

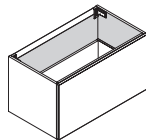

P. 36.7 - 45.5 - 51
L. 30 - 45 - 60 - 75 - 90 -
105 - 120 - 135

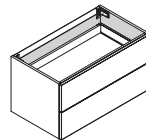

P. 36.7 - 45.5 - 51
L. 30 - 45 - 60 - 75 - 90 -
105 - 120 - 135

H. 60

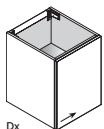

P. 36.7 - 45.5 - 51
L. 30 - 45

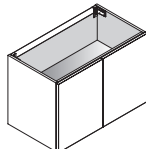

P. 36.7 - 45.5 - 51
L. 60 - 75 - 90 - 105 - 120

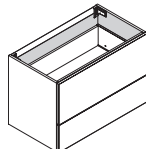

P. 36.7 - 45.5 - 51
L. 30 - 45 - 60 - 75 - 90 -
105 - 120 - 135

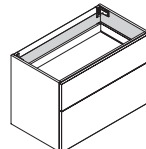

P. 36.7 - 45.5 - 51
L. 30 - 45 - 60 - 75 - 90 -
105 - 120 - 135

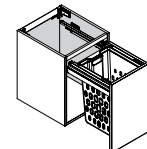

P. 51
L. 45

H. 79

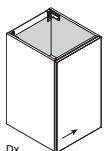

P. 36.7 - 45.5 - 51
L. 30 - 45

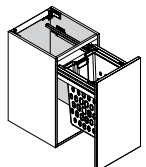

P. 51
L. 45

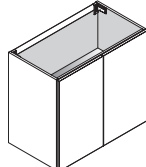

P. 36.7 - 45.5 - 51
L. 60 - 75 - 90 - 105 - 120

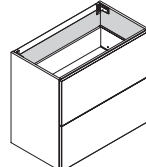

P. 36.7 - 45.5 - 51
L. 30 - 45 - 60 - 75 - 90 -
105 - 120 - 135

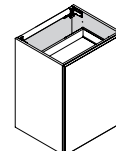

P. 51
L. 60 - 75

H. 88

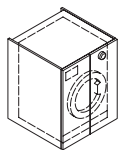

P. 51 - 69.5
L. 75

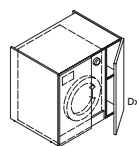

P. 51 - 69.5
L. 90

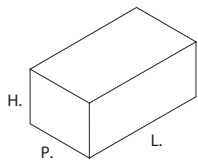

ELEMENTI A GIORNO
OPEN SHELF UNITS
MEUBLES OUVERTS
ELEMENTOS ABIERTOS

H. 24



P. 36.7 - 45.5 - 51
L. 15÷30 - 30,1÷45 - 45,1÷60

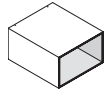

P. 36.7 - 45.5 - 51
L. 30 - 45 - 60

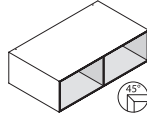

P. 36.7 - 45.5 - 51
L. 75 - 90 - 105 - 120

H. 39,5



P. 36.7 - 45.5 - 51
L. 15÷30 - 30,1÷45 - 45,1÷60

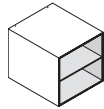

P. 36.7 - 45.5 - 51
L. 30 - 45



Sx



P. 36.7 - 45.5 - 51
L. 15 - 30



Sx



P. 36,7 ÷ 45,5 - 36,7 ÷ 51
L. 30



Sx



P. 36.7 - 45.5 - 51
L. 15

H. 48

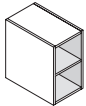

P. 36.7 - 45.5 - 51
L. 15÷30 - 30,1÷45 - 45,1÷60

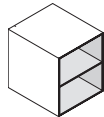

P. 36.7 - 45.5 - 51
L. 30 - 45

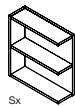

Sx



P. 36.7 - 45.5 - 51
H. 48
L. 15 - 30



Sx



P. 36,7 ÷ 45,5 - 36,7 ÷ 51
L. 30



Sx



P. 36.7 - 45.5 - 51
H. 48
L. 15

H. 60

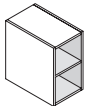

P. 36.7 - 45.5 - 51
L. 15÷30 - 30,1÷45 - 45,1÷60

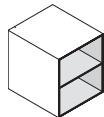

P. 36.7 - 45.5 - 51
L. 30 - 45

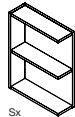

Sx



P. 36.7 - 45.5 - 51
H. 63
L. 15 - 30

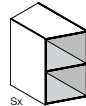

Sx



P. 36,7 ÷ 45,5 - 36,7 ÷ 51
L. 30

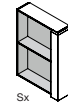

Sx



P. 36.7 - 45.5 - 51
H. 63
L. 15

H. 79

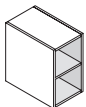

P. 36.7 - 45.5 - 51
L. 15÷30 - 30,1÷45 - 45,1÷60

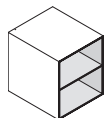

P. 36.7 - 45.5 - 51
L. 30 - 45

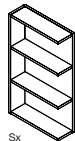

Sx



P. 36.7 - 45.5 - 51
L. 15 - 30

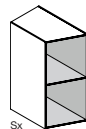

Sx



P. 36,7 ÷ 45,5 - 36,7 ÷ 51
L. 30

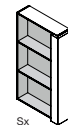

Sx



P. 36.7 - 45.5 - 51
L. 15

CARRELLI
TROLLEYS
CHARIOTS
CASTORO

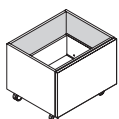

P. 42 - 51
H. 46.5
L. 60 - 75 - 90

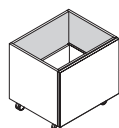

P. 42 - 51
H. 55
L. 60 - 75 - 90

COLLEZIONE

MODO PROJECT_GOLA

altamarea

BATHROOM
BOUTIQUE

MODO PROJECT_GOLA

Informazioni tecniche

Technical information
Informations techniques
Notas técnicas

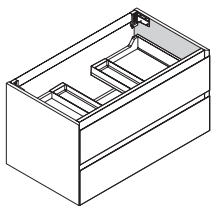

BASE REGGILAVABO SOSPESA

Frontali Sp. 2,2 cm
 • Melaminico/Tecnomatt
 • Laccato Sand / Lucido / Ossidato
 • Fenix NTM® / Laminato
 • Rovere / Essenze
 • Traccia (solo frontali, fianchi in Rovere)

Scocca
 • Pannello melaminico sp. 1,8 cm finitura bianco o grafite

Attaccaglie in acciaio regolabili con barra di rinforzo in alluminio, portata max 120 kg.

HANGING WASHBASIN UNIT

Front panels th. 2,2 cm.
 • Melamine/Tecnomatt
 • Sand lacquered / Glossy / Oxidised
 • Fenix NTM® / Laminato
 • Oak / Woods
 • Traccia
 Visible side panels (Included in the price)

Carcase
 • 1,8 cm thick melamine panel white or graphite

St. Steel adjustable brackets with aluminium reinforcement bar. Maximum loading capacity 120 kg.

BAS POUR LAVABO SUSPENDU

Façades de 2,2 cm d'épaisseur
 • Mèlaminé/Tecnomatt
 • Laqué Sand / brillant / oxydé
 • Fenix NTM® / Stratifié
 • Chêne / Bois
 • Traccia
 Côtés visibles (inclus dans le prix)

Caisson
 • Panneau mélaminé ép. 1,8 cm finition blanc ou graphite

Accroches en acier réglables avec barre de renfort en aluminium, portée max. 120 kg.

MUEBLE PARA LAVABO COLGANTE

Frentes de 2,2 cm
 • Melaminico/Tecnomatt
 • Lacado Sand / brillo / oxidado
 • Fenix NTM® / Laminado
 • Roble / Maderas
 • Traccia
 Lados vistos (incluidos en el precio)

Bastidor
 • Panel en melamina esp. 1,8 cm acabado blanco o grafite

Soportes en acero ajustables con barra de refuerzo en aluminio, capacidad max. 120 kg

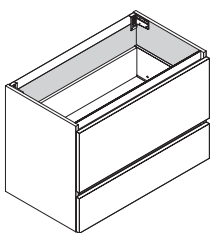

BASE ARREDO SOSPESA

Materiali, finiture e maniglie come base reggilavabo sospesa
 • Schiena in finitura bianco o grafite sp. 0,5 cm

Attaccaglie in acciaio regolabili con barra di rinforzo in alluminio, portata max 120 kg.

WALL HANGING BASE UNIT

Materials and finishes are the same as the suspended washbasin units
 • 0,5 cm thick back panel white or graphite

St. Steel adjustable brackets with aluminium reinforcement bar. Maximum loading capacity 120 kg.

MEUBLE BAS SUSPENDU

Matériaux et finitions comme pour bas porte-vasque suspendu
 • Dos en finition blanc ou graphite ép. 0,5 cm

Accroches en acier réglables avec barre de renfort en aluminium, portée max. 120 kg.

MUEBLE BASE COLGANTE

Materiales y acabados como mueble para lavabo
 • Trasera en acabado blanco o grafite esp. 0,5 cm

Soportes en acero ajustables con barra de refuerzo en aluminio, capacidad max. 120 kg

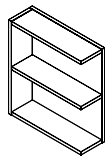
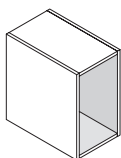

BASE JOLLY A GIORNO

• Scocca in pannello sp. 1,8 cm in tutte le finiture dei frontali
 • Schiena in pannello sp. 1 cm in tutte le finiture dei frontali

Attaccaglie a scomparsa con regolazione dall'interno

JOLLY OPEN SHLED BASE UNIT

• 1,8 cm thick carcasse panel available in all finishes of door's fronts
 • 1 cm thick back panel available in all finishes

Concealed and adjustable wall supports

BAS OUVERT JOLLY

• Caisson en panneau ép. 1,8 cm dans toutes les finitions des façades
 • Dos en panneau ép. 1 cm dans toutes les finitions des façades

Accroches rétractables avec réglage de l'intérieur

BASE JOLLY ABIERTA

• Bastidor en panel esp. 1,8 cm en todos los acabados de los frentes
 • Trasera en panel esp. 1 cm en todos los acabados de los frentes

Soportes ocultos que se ajustan desde el interior

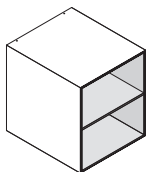

ELEMENTI A GIORNO

• Scocca in pannello Sp. 1 cm in tutte le finiture dei frontali
 • Schiena in pannello sp. 1 cm in tutte le finiture dei frontali

Attaccaglie a scomparsa regolabili dall'alto

OPEN SHELF UNITS

• 1 cm thick carcasse panel available in all finishes of door's fronts
 • 1 cm thick back panel available in all finishes

Concealed and adjustable brackets

MEUBLES OUVERTS

• Caisson fabriqué avec panneaux ép. 1 cm dans toutes les finitions en gamme pour les façades
 • Dos en panneau ép. 1 cm dans toutes les finitions des façades

Accroches rétractables réglables depuis le haut

ELEMENTOS ABIERTOS

• casco en panel de 1 cm de grosor en todos los acabados de frente
 • Trasera en panel esp. 1 cm en todos los acabados de los frentes

Soportes ocultos ajustable por arriba

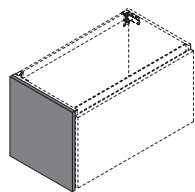

FIANCO A RIDOSSO (su richiesta vedi pag. 134)

• Pannello sp. 1 cm o 2,2 cm da affiancare al mobile disponibile in tutte le finiture dei frontali
 • Traccia (solo fianchi Sp. 2,2 cm)

ADDITIONAL SIDE PANEL (on request, please refer to page 134)

• 1 or 2,2 cm thick additional side panel, available in all finishes of the door's fronts
 • Traccia (only side panels th.2,2cm)

JOUE EN SURÉPAISSEUR (sur demande voir page 134)

• Panneau ép. 1 cm et 2,2 cm à positionner à côté du meuble
 • Traccia (joes uniquement en ép. 2,2 cm)

COSTADO SOBREPUESTO (bajo pedido ver pag 134)

• Panel esp. 1 cm o 2,2 cm por acostar al mueble disponible en todos los acabados de los frentes
 • Traccia (solo costados de 2,2 cm de grosor)

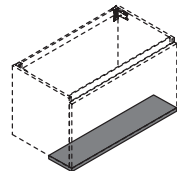

FASCIA INFERIORE (su richiesta vedi pag. 134)

• Pannello estetico sp. 1 cm da fissare sul lato inferiore del mobile disponibile in tutte le finiture dei frontali

Lower strip panel (upon request, see page 134)

• 1 cm thick back to be applied underneath the cabinets, available in all finishes

Profil inférieur (sur demande voir page 134)

• Panneau esthétique ép. 1 cm à fixer sur le côté inférieur du meuble disponible dans toutes les finitions des façades

Tapeta inferior (bajo pedido ver pag 134)

• Tapeta de cierre inferior estética esp. 1 cm por sujetar en la parte abajo del mueble disponible en todos los acabados de los frentes

Cod: **FGBS010** Cod: **FGBI010**

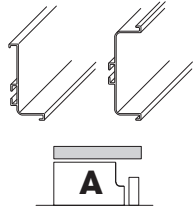

GOLA CURVA (Bordo dritto)

Gola Curva superiore ed intermedia per anta bordo dritto

CURVED CHANNEL (Door with straight edge)

Upper and intermediate curve channel for straight edge door

GORGE CREUSE (porte avec chants droits)

Gorge Courbe supérieure et intermédiaire pour porte à chant droit

gola CURVADA (canto recto)

Gola curvada superior e intermedia para puerta canto recto

Cod: **FGBS025** Cod: **FGBI025**

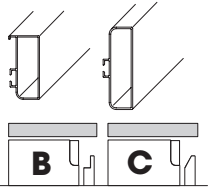

GOLA PIATTA (Profilo Step e 30°)

Gola Piatta superiore ed intermedia per anta profilo step e profilo 30°

FLAT CHANNEL (Door with Step and 30° profile)





Upper and intermediate flat channel for step profile and 30° profile door

GORGE PLATE (porte avec profil Step et profil 30°)

Rainure plate supérieure et intermédiaire pour profil de marche et porte à profil 30°

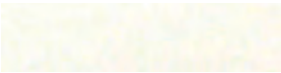
gola PLANA (profil Step y 30°)

Gola plana superior e intermedia para perfil de paso y puerta de perfil de 30°

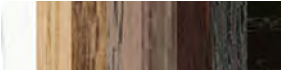
Abbinamento di serie gola <i>Groove series combination</i> <i>Combinaison de séries de rainures</i> <i>Combinación de series de ranuras</i>	MELAMINICO/ TECNOMATT	LACCATO SAND/LUCIDO	LACCATO OSSIDATO	LAMINATO HPL	FENIX NTM®	ROVERE	ESSENZE	TRACCIA
 Alluminio satinato		<ul style="list-style-type: none"> Grigio Chiaro Grigio Fine 		<ul style="list-style-type: none"> Pietra Lavica Piasentina 	<ul style="list-style-type: none"> Grigio Antrim 			
 Bianco	<ul style="list-style-type: none"> Calce 73 Polar 	<ul style="list-style-type: none"> Bianco Puro 		<ul style="list-style-type: none"> Malta Bianca 	<ul style="list-style-type: none"> Bianco Kos Bianco Malè 	<ul style="list-style-type: none"> Rovere Bianco 		<ul style="list-style-type: none"> Rovere Bianco
 Brunito	<ul style="list-style-type: none"> Fumo Dolphin 22 Calce 08 Moro Verde Timo Smoke Bruma 22 Noce Light 	<ul style="list-style-type: none"> Ardesia Aston Fango Grigio Blu Grigio Londra Grigio Marrone Grigio Medio Grigio Jaipur Marrone Arancio Nero Petrolio Rosmarino Rosso Vino Tiffany Verde Acido Cipria 	<ul style="list-style-type: none"> Acciaio Bronzo Piombo 	<ul style="list-style-type: none"> Nero Tecno Nocturne Cesar Brown Stone Rovere Bruciato Noce Savoia 	<ul style="list-style-type: none"> Verde Comodoro Grigio Londra Rosso Jaipur Blu Shaba Grigio Aragona Grigio Bromo Nero Ingo 	<ul style="list-style-type: none"> Rovere Atlas Rovere Scuro Rovere Cacao Rovere Savana Rovere Nero 	<ul style="list-style-type: none"> Noce Canaletto Rovere Termocotto Eucalipto Termocotto Sabbiato Cortina Olmo Naturale 	<ul style="list-style-type: none"> Rovere Atlas Rovere Scuro Rovere Cacao Rovere Savana Rovere Nero
 Champagne	<ul style="list-style-type: none"> Seta 22 Calce 45 Calce 51 Rovere Fanes Gobin Maui Chamonix 22 Columbia 22 	<ul style="list-style-type: none"> Arena Argilla Bianco Perla Castoro Ottawa Giallo Ambra Mandorla 	<ul style="list-style-type: none"> Ghisa Ottone Gold 	<ul style="list-style-type: none"> Rovere Monet Quercia Grigia Rovere Wafer Malta Grigia Malta Canapa 	<ul style="list-style-type: none"> Beige Arizona Castoro Ottawa 	<ul style="list-style-type: none"> Rovere Chiaro Rovere Tostato 	<ul style="list-style-type: none"> Rovere Nodino Chiaro Olmo Sabbiato Sabbiato Amalfi Rovere Nodino Chiaro 	<ul style="list-style-type: none"> Rovere Chiaro Rovere Tostato
 Laccato	<p>Maggiorazione per gola in finitura anta (€/ml. 35) <i>Surcharge for finished channel profile (35€ per linear meter)</i> <i>Supplément pour gorge assortie à la façade (€ 35 au ml)</i> <i>Recargo por gola en acabado puerta (€/ml. 35)</i></p>							
 Rovere	<p>Maggiorazione per gola in finitura anta (€/ml. 35) <i>Surcharge for finished channel profile (35€ per linear meter)</i> <i>Supplément pour gorge assortie à la façade (€ 35 au ml)</i> <i>Recargo por gola en acabado puerta (€/ml. 35)</i></p>							

MODO PROJECT_GOLA

Modularità
Modularity
Modularité
Modularidad

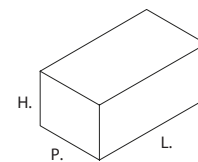

BASE REGGILAVABO

WASHBASIN UNITS
MEUBLE PAS PORTE-VASQUE
MUEBLES LAVABOS

H. 27

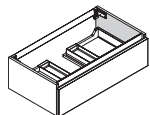

P. P. 36.7 - 45.5 - 51
L. L. 60 - 75 - 90 - 105 -
120 - 135

H. 42,5

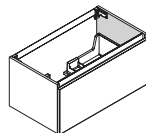

P. P. 36.7 - 45.5 - 51
L. L. 60 - 75 - 90 - 105 -
120 - 135

H. 51

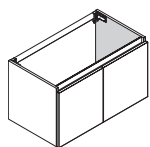

P. P. 36.7 - 45.5 - 51
L. L. 60 - 75 - 90 - 105 -
120

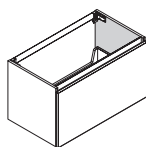

P. P. 36.7 - 45.5 - 51
L. L. 60 - 75 - 90 - 105 -
120 - 135

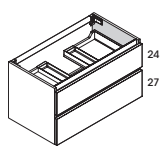

P. P. 36.7 - 45.5 - 51
L. L. 60 - 75 - 90 - 105 -
120 - 135

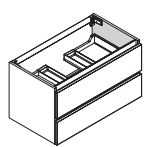

P. P. 36.7 - 45.5 - 51
L. L. 60 - 75 - 90 - 105 -
120 - 135

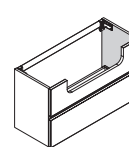

P. P. 36.7
L. L. 75 - 90 - 105 - 120 -
135

H. 63

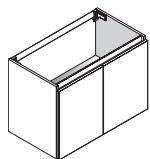

P. P. 36.7 - 45.5 - 51
L. L. 60 - 75 - 90 - 105 -
120

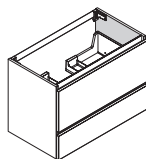

P. P. 36.7 - 45.5 - 51
L. L. 60 - 75 - 90 - 105 -
120 - 135

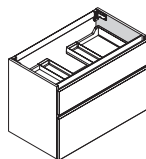

P. P. 36.7 - 45.5 - 51
L. L. 60 - 75 - 90 - 105 -
120 - 135

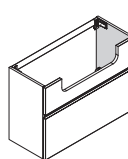

P. P. 36.7
L. L. 75 - 90 - 105 - 120 -
135

H. 82

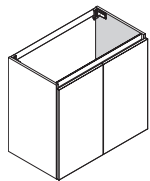

P. P. 36.7 - 45.5 - 51
L. L. 60 - 75 - 90 - 105 -
120

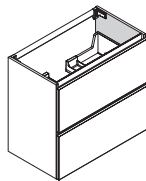

P. P. 36.7 - 45.5 - 51
L. L. 60 - 75 - 90 - 105 -
120 - 135

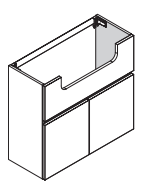

P. P. 36.7
L. L. 90 - 120

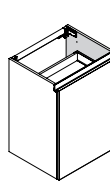

P. P. 51
L. L. 75 - 60

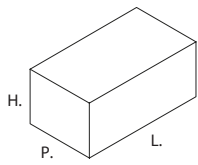

BASE ARREDO
UNIT BASE
ÉLEMENT BAS
MUEBLE BAJO

H. 27

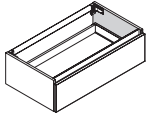

P. P. 36.7 - 45.5 - 51
L. L. 30 - 45 - 60 - 75 - 90 -
105 - 120 - 135

H. 42,5

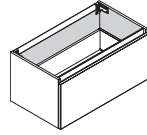

P. P. 36.7 - 45.5 - 51
L. L. 30 - 45 - 60 - 75 - 90 -
105 - 120 - 135

H. 51

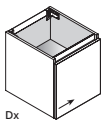

P. P. 36.7 - 45.5 - 51
L. L. 30 - 45

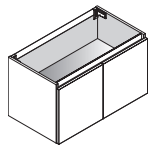

P. P. 36.7 - 45.5 - 51
L. L. 60 - 75 - 90 - 105
- 120

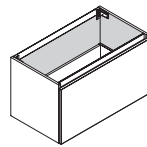

P. P. 36.7 - 45.5 - 51
L. L. 30 - 45 - 60 - 75 - 90 -
105 - 120 - 135

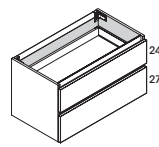

P. P. 36.7 - 45.5 - 51
L. L. 30 - 45 - 60 - 75 - 90 -
105 - 120 - 135

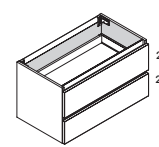

P. P. 36.7 - 45.5 - 51
L. L. 30 - 45 - 60 - 75 - 90 -
105 - 120 - 135

H. 63

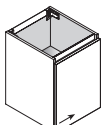

P. P. 36.7 - 45.5 - 51
L. L. 30 - 45

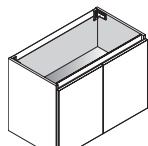

P. P. 36.7 - 45.5 - 51
L. L. 60 - 75 - 90 - 105
- 120

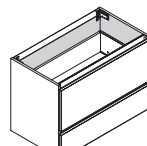

P. P. 36.7 - 45.5 - 51
L. L. 30 - 45 - 60 - 75 - 90 -
105 - 120 - 135

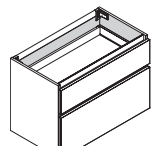

P. P. 36.7 - 45.5 - 51
L. L. 30 - 45 - 60 - 75 - 90 -
105 - 120 - 135

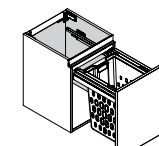

P. P. 51
L. L. 45

H. 82

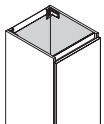

P. P. 36.7 - 45.5 - 51
L. L. 30 - 45

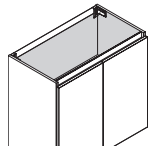

P. P. 36.7 - 45.5 - 51
L. L. 60 - 75 - 90 - 105
- 120

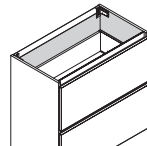

P. P. 36.7 - 45.5 - 51
L. L. 30 - 45 - 60 - 75 - 90 -
105 - 120 - 135

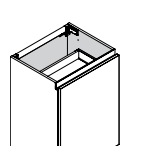

P. P. 51
L. L. 75 - 60

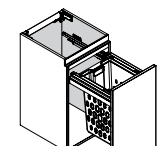

P. P. 51
L. L. 45

H. 88

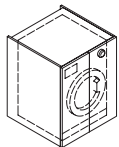

P. P. 51 - 69.5
L. L. 75

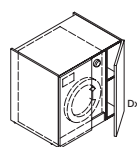

P. P. 51 - 69.5
L. L. 90

MODULO PROJECT_GOLA

Modularità
Modularity
Modularité
Modularidad

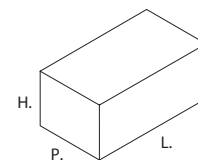

ELEMENTI A GIORNO OPEN SHELF UNITS MEUBLES OUVERTS ELEMENTOS ABIERTOS

H. 27



P. P. 36,7 - 45,5 - 51
L. L. 15÷30 - 30,1÷45 -
45,1÷60

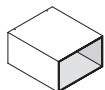

P. P. 36,7 - 45,5 - 51
L. L. 30 - 45 - 60

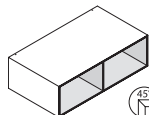

P. P. 36,7 - 45,5 - 51
L. L. 75 - 90 - 105 - 120

H. 42,5

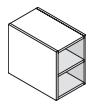

P. P. 36,7 - 45,5 - 51
L. L. 15÷30 - 30,1÷45 -
45,1÷60

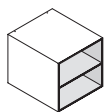

P. P. 36,7 - 45,5 - 51
L. L. 30 - 45

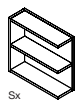

Sx



P. P. 36,7 - 45,5 - 51
L. L. 15 - 30



Sx



P. P. 36,7 ÷ 45,5 - 36,7
÷ 51
L. L. 30



Sx



P. P. 36,7 - 45,5 - 51
L. L. 15

H. 51

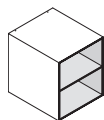

P. P. 36,7 - 45,5 - 51
L. L. 30 - 45

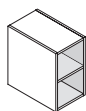

P. P. 36,7 - 45,5 - 51
L. L. 15÷30 - 30,1÷45 -
45,1÷60

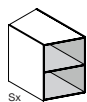

Sx



P. P. 36,7 ÷ 45,5 - 36,7
÷ 51
L. L. 30

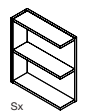

Sx



P. P. 36,7 - 45,5 - 51
L. L. 15 - 30

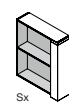

Sx



P. P. 36,7 - 45,5 - 51
L. L. 15

H. 63

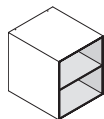

P. P. 36,7 - 45,5 - 51
L. L. 30 - 45

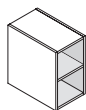

P. P. 36,7 - 45,5 - 51
L. L. 15÷30 - 30,1÷45 -
45,1÷60

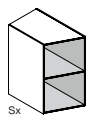

Sx



P. P. 36,7 ÷ 45,5 - 36,7
÷ 51
L. L. 30

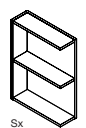

Sx



P. P. 36,7 - 45,5 - 51
L. L. 15 - 30

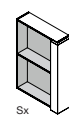

Sx



P. P. 36,7 - 45,5 - 51
L. L. 15

H. 82

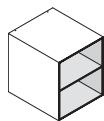

P. P. 36,7 - 45,5 - 51
L. L. 30 - 45

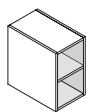

P. P. 36,7 - 45,5 - 51
L. L. 15÷30 - 30,1÷45 -
45,1÷60

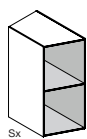

Sx



P. P. 36,7 ÷ 45,5 - 36,7
÷ 51
L. L. 30

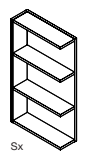

Sx



P. P. 36,7 - 45,5 - 51
L. L. 15 - 30

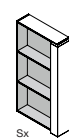

Sx



P. P. 36,7 - 45,5 - 51
L. L. 15

CARRELLI TROLLEYS CHARIOTS CASTORO

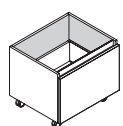

P. P. 42 - 51
H. L. 49,5
L. L. 60 - 75 - 90

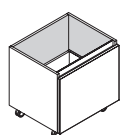

P. P. 42 - 51
H. L. 58
L. L. 60 - 75 - 90

COLLEZIONE

MODO_LAUNDRY

altamarea[®]

BATHROOM
BOUTIQUE

MODO_LAUNDRY

Informazioni tecniche

Technical information
Informations techniques
Notas técnicas

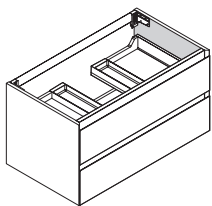

BASE REGGILAVABO SOSPESA

Frontali e fianchi a vista (inclusi nel prezzo)
• Melaminico/Tecnomatt
• Laccato Sand / Lucido / Ossidato
• Fenix NTM®
• Rovere / Essenze
• Traccia (solo frontali, fianchi in Rovere)

Scocca
• Pannello melaminico sp. 1,8 cm finitura bianco o grafite

Disponibile con maniglia esterna o maniglia integrata Groove

Affaccaglie in acciaio regolabili con barra di rinforzo in alluminio, portata max 120 kg.

Versione con gola di serie (tipologie e finiture vedi pag.

Versione con maniglia su richiesta (tipologie e prezzi vedi pag.

HANGING WASHBASIN UNIT

Visible fronts and sides (included in the price)
• Melamine/Tecnomatt
• Sand lacquered / Glossy / Oxidised
• Fenix NTM®
• Oak / Woods
• Traccia

Carcase
• 1,8 cm thick melamine panel white or graphite

Available with external handle or Groove integrated handle

St. Steel adjustable brackets with aluminium reinforcement bar. Maximum loading capacity 120 kg.

With channel as standard (configurations and finishes, please refer to page

With handle upon request (configurations and prices, please refer to page

BAS POUR LAVABO SUSPENDU

Façades et côtés finis (compris dans le prix)
• Mélaminé/Tecnomatt
• Laqué Sand / brillant / oxydé
• Fenix NTM®
• Chêne / Bois
• Traccia

Caisson
• Panneau mélaminé ép. 1,8 cm finition blanc ou graphite

Disponible avec poignée externe ou poignée intégrée Groove

Accroches en acier réglables avec barre de renfort en aluminium, portée max. 120 kg.

Version avec gorge de série (type et finition voir page

Version avec poignée sur demande (type et prix voir page

MUEBLE PARA LAVABO COLGANTE

Frentes y laterales vistos (incluidos en el precio)
• Melaminico/Tecnomatt
• Laccado Sand / brillo / oxidado
• Fenix NTM®
• Roble / Maderas
• Traccia

Bastidor
• Panel en melamina esp. 1,8 cm acabado blanco o grafite

Disponible con tirador exterior o con el tirador Groove integrado

Soportes en acero ajustables con barra de refuerzo en aluminio, capacidad max. 120 kg

Versión con agarre gola de serie (tipologías y acabados ver pag.

Versión con tirador bajo pedido (tipologías y precios ver pag.

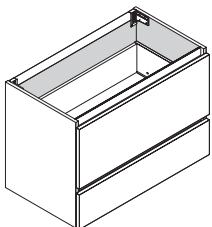

BASE ARREDO SOSPESA

Materiali, finiture e maniglie come base reggilavabo sospesa
• Schiena in finitura bianco o grafite sp. 0,5 cm

Affaccaglie in acciaio regolabili con barra di rinforzo in alluminio, portata max 120 kg.

WALL HANGING BASE UNIT

Materials and finishes are the same as the suspended washbasin units
• 0,5 cm thick back panel white or graphite

St. Steel adjustable brackets with aluminium reinforcement bar. Maximum loading capacity 120 kg.

MEUBLE BAS SUSPENDU

Matériaux et finitions comme pour bas porte-vasque suspendu
• Dos en finition blanc ou graphite ép. 0,5 cm

Accroches en acier réglables avec barre de renfort en aluminium, portée max. 120 kg.

MUEBLE BASE COLGANTE

Materiali e acabados como mueble para lavabo
• Trasera en acabado blanco o grafite esp. 0,5 cm

Soportes en acero ajustables con barra de refuerzo en aluminio, capacidad max. 120 kg

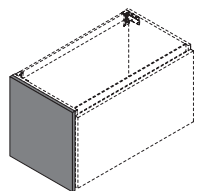

FIANCO A RIDOSSO (su richiesta vedi pag

• Pannello sp. 1 cm o 2,2 cm da affiancare al mobile disponibile in tutte le finiture dei frontali
• Traccia (solo fianchi Sp. 2,2 cm)

ADDITIONAL SIDE PANEL (on request, please refer to page

• 1 or 2,2 cm thick additional side panel, available in all finishes of the door's fronts
• Traccia (only side panels th.2,2cm)

JOUE EN SURÉPAISSEUR (sur demande voir page

• Panneau ép. 1 cm et 2,2 cm à positionner à côté du meuble
• Traccia (joints uniquement en ép. 2,2 cm)

COSTADO SOBREPUESTO (bajo pedido ver pag

• Panel esp. 1 cm o 2,2 cm por acostar al mueble disponible en todos los acabados de los frentes
• Traccia (solo costados de 2,2 cm de grosor)

Cod: FGBS010 Cod: FGBI010

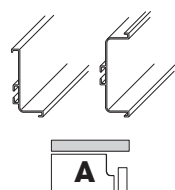

GOLA CURVA (Bordo dritto)

Gola Curva superiore ed intermedia per anta bordo dritto

CURVED CHANNEL (Door with straight edge)

Upper and intermediate curve channel for straight edge door

GORGE CREUSE (porte avec chants droits)

Gorge Courbe supérieure et intermédiaire pour porte à chant droit

gola CURVADA (canto recto)

Gola curvada superior e intermedia para puerta canto recto

Cod: FGBS025 Cod: FGBI025

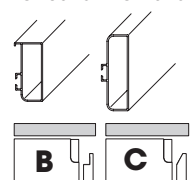

GOLA PIATTA (Profilo Step e 30°)

Gola Piatta superiore ed intermedia per anta profilo step e profilo 30°

FLAT CHANNEL (Door with Step and 30° profile)

Upper and intermediate flat channel for step profile and 30° profile door

GORGE PLATE (porte avec profil Step et profil 30°)

Rainure plate supérieure et intermédiaire pour profil de marche et porte à profil 30°

gola PLANA (profil Step y 30°)

Gola plana superior e intermedia para perfil de paso y puerta de perfil de 30°

Per abbinamenti finitura gola di serie vedere pag. 101, per abbinamenti di serie maniglia Groove vedi pag. 60

For standard groove finish combinations see page 101, for standard Groove handle combinations see page 60

Pour les combinaisons de finitions rainurées standard, voir page 101, pour les combinaisons de poignées rainurées standard, voir page 60

Para combinaciones de acabado de ranura estándar, consulte la página 101, para combinaciones de mango de ranura estándar, consulte la página 60

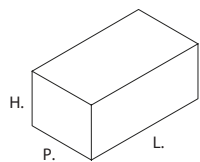

BASE REGGILAVABO
BASE REGGILAVABO
BASE REGGILAVABO
BASE REGGILAVABO

H. 82 CON GOLA

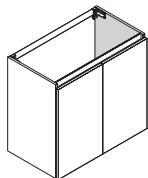

P. P. 51 - 69.5
L. L. 60 - 75 - 90 - 105 - 120

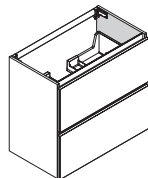

P. P. 51 - 69.5
L. L. 60 - 75 - 90 - 105 - 120 - 135

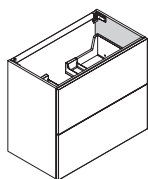

P. P. 51 - 69.5
L. L. 60 - 75 - 90 - 105 - 120 - 135

H. 79 CON MANIGLIA

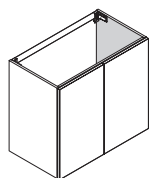

P. P. 51 - 69.5
L. L. 60 - 75 - 90 - 105 - 120

BASE ARREDO
BASE ARREDO
BASE ARREDO
BASE ARREDO

H. 82 CON GOLA

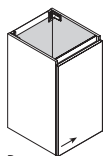

Dx
P. P. 51 - 69.5
L. L. 30 - 45

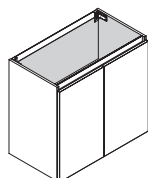

P. P. 51 - 69.5
L. L. 60 - 75 - 90 - 105 - 120

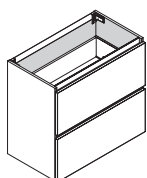

P. P. 51 - 69.5
L. L. 60 - 75 - 90 - 105 - 120 - 135

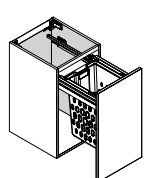

P. P. 51 - 70
L. L. 45

H. 79 CON MANIGLIA

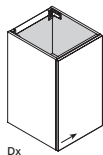

Dx
P. P. 51 - 69.5
L. L. 30 - 45

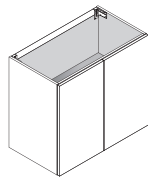

P. P. 51 - 69.5
L. L. 60 - 75 - 90 - 105 - 120

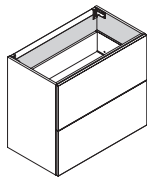

P. P. 51 - 69.5
L. L. 60 - 75 - 90 - 105 - 120 - 135

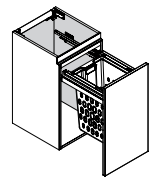

P. P. 51 - 70
L. L. 45

H. 88

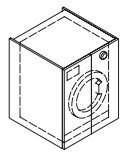

P. P. 51 - 69.5
L. L. 75

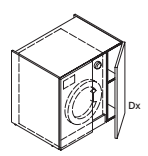

P. P. 51 - 69.5
L. L. 90

MODULO_LAUNDRY

Modularità
Modularity
Modularité
Modularidad

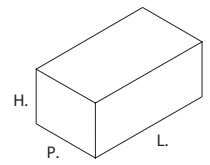

BASAMENTI
BASAMENTI
BASAMENTI
BASAMENTI

CON GOLA

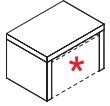

P. P. 51.5 - 70
H. L. 49.5
L. L. 72

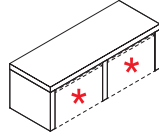

P. P. 51.5 - 70
H. L. 49.5
L. L. 138

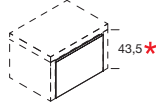

P. P. 51
H. L. 72
L. L. 60

CON MANIGLIA

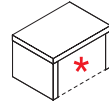

P. P. 51.5 - 70
H. L. 46.5
L. L. 72

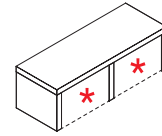

P. P. 51.5 - 70
H. L. 46.5
L. L. 138

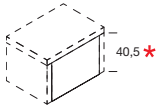

P. P. 51
H. L. 72
L. L. 60

COLONNE PORTALAVATRICI
COLONNE PORTALAVATRICI
COLONNE PORTALAVATRICI
COLONNE PORTALAVATRICI

H. 145

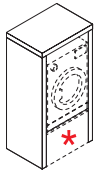

P. P. 51.5 - 70
H. L. 145
L. L. 77,5

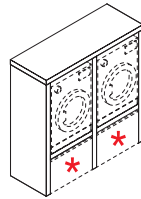

P. P. 51.5 - 70
H. L. 145
L. L. 148,5

H. 193

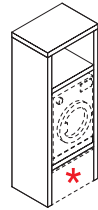

P. P. 51.5 - 70
H. L. 193
L. L. 77,5

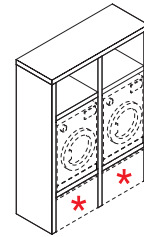

P. P. 51.5 - 70
H. L. 193
L. L. 148,5

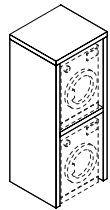

P. P. 70
H. L. 193
L. L. 77,5

SOPRACOLONNA
SOPRACOLONNA
SOPRACOLONNA
SOPRACOLONNA

H. 193

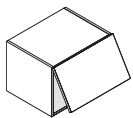

P. P. 70
H. L. 43
L. L. 77,5

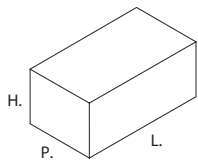

PENSILI BORDO DRITTO
WALL UNITS WITH STRAIGHT EDGE
AVEC CHANT DROIT
MUEBLES ALTO CON CANTO RECTO

P. 21,2

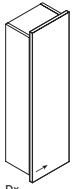

H. 48 - 60 - 72 - 96 - 120
- 144 - 168
L. 30

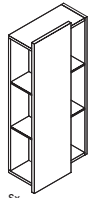

H. 72 - 96 - 120 - 144
- 168
L. 45

P. 19

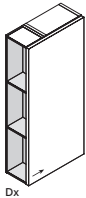

H. 48 - 60 - 72 - 96 - 120
L. 45 - 60

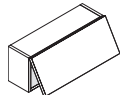

H. 24 - 36
L. 60 - 75 - 90 - 105 -
120

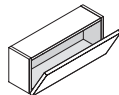

H. 24 - 36
L. 60 - 75 - 90 - 105 -
120



H. 48 - 60 - 72 - 96 - 120
L. 30 - 45 - 60

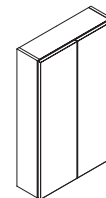

H. 48 - 60 - 72 - 96 - 120
L. 60 - 90



H. 48 - 60 - 72 - 96 - 120
L. 30 - 45

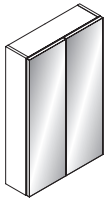

H. 48 - 60 - 72 - 96 - 120
L. 60 - 90

P. 36,7

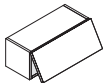

H. 24 - 36
L. 60 - 75 - 90 - 105 -
120

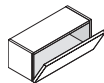

H. 24 - 36
L. 60 - 75 - 90 - 105 -
120



H. 48 - 60 - 72 - 96 - 120
L. 30 - 45

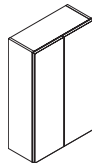

H. 48 - 60 - 72 - 96 - 120
L. 60 - 90



H. 48 - 60 - 72 - 96 - 120
L. 30 - 45

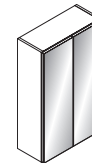

H. 48 - 60 - 72 - 96 - 120
L. 60 - 90

P. 69,5

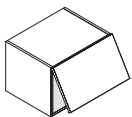

H. 36 - 48 - 60
L. 45 - 60 - 75 - 90

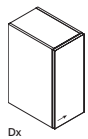

H. 48 - 60
L. 45 - 60

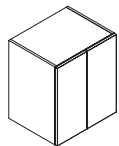

H. 48 - 60
L. 90

PENSILI BORDO DRITTO

Modularità
Modularity
Modularité
Modularidad

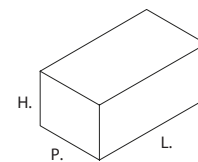

PENSILI A GIORNO WALL UNITS OPEN ÉLÉMENTS HAUTS OUVERT MUEBLES ALTO ABIERTO

P. 19



H. 24
L. 30 - 45 - 60

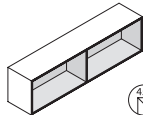

H. 24
L. 75 - 90 - 105 - 120

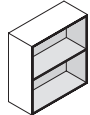

H. 36 - 48 - 60 - 72
L. 30 - 45 - 60



H. 24 - 36 - 48 - 60 - 72
L. 15÷30 - 30,1÷45

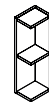

H. 36 - 48 - 60 - 72 - 96
- 120
L. 15 - 30

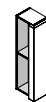

H. 36 - 48 - 60 - 72 - 96
- 120
L. 15

P. 36,7

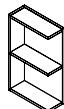

P. P. 36.7
H. 36 - 48 - 63 - 72 - 120
L. 15 - 30



P. P. 36.7
H. 36 - 48 - 63 - 72 - 96 - 120
L. 15

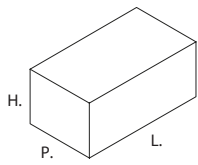

PENSILI BORDO 45°

WALL UNITS WITH 45° EDGES
ÉLÉMENTS HAUTS AVEC CHANT À 45°
MUEBLES ALTO CON CANTO 45°

P. 22

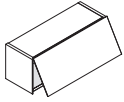

H. 24 - 36
L. 45 - 60 - 75 - 90



H. 48 - 60 - 72 - 96 - 120
L. 30 - 45 - 60

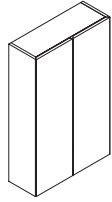

H. 48 - 60 - 72 - 96 - 120
L. 60 - 90

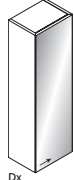

H. 48 - 60 - 72 - 96 - 120
L. 30 - 45 - 60

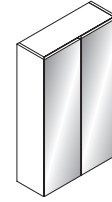

H. 48 - 60 - 72 - 96 - 120
L. 60 - 90

PENSILI A GIORNO CON BORDI 45°

WALL UNITS OPEN WITH 45° EDGES
ÉLÉMENTS HAUTS OUVERTS AVEC CHANT À 45°
MUEBLES ALTO ABIERTOS CON CANTO 45°

P. 22

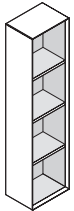

H. 24 - 36 - 48 - 60 - 72 -
96 - 120 - 144 - 168 - 192
L. 30 - 45 - 15

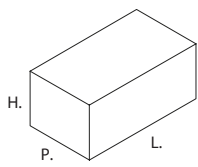

COLONNE SOSPESSE BORDO DRITTO
TALL UNITS SUSPENDED WITH STRAIGHT EDGE
COLONNES SUSPENDUES AVEC CHANT DROIT
COLUMNAS SUSPENDIDAS CON CANTO RECTO

P. 19

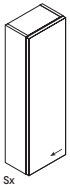

H. 144 - 168 - 192
L. 30 - 45 - 60

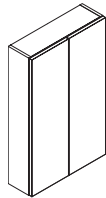

H. 144 - 168 - 192
L. 60



H. 144 - 168 - 192
L. 30 - 45 - 60

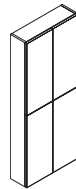

H. 144 - 168 - 192
L. 60

COLONNE A TERRA BORDO DRITTO CON ANTA
FLOOR-STANDING TALL UNITS STRAIGHT EDGE WITH DOORS
COLONNES AU SOL CHANT DROIT AVEC PORTE
COLUMNAS A SUELO CANTO RECTO CON PUERTA

P. 36,7

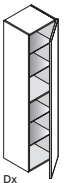

H. 144 - 168 - 192 - 218
- 235
L. 30 - 45 - 60

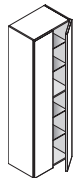

H. 144 - 168 - 192 - 218
- 235
L. 60



H. 144 - 168 - 192 - 235
L. 30 - 45 - 60

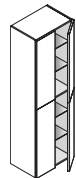

H. 144 - 168 - 192 - 235
L. 60

P. 45,5

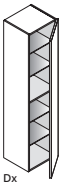

H. 144 - 168 - 192 - 218
- 235
L. 30 - 45 - 60

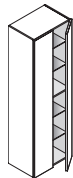

H. 144 - 168 - 192 - 218
- 235
L. 60



H. 144 - 168 - 192 - 235
L. 30 - 45 - 60

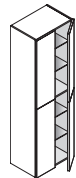

H. 144 - 168 - 192 - 235
L. 60

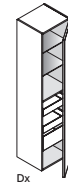

H. 144 - 168 - 192 - 218
- 235
L. 45 - 30 - 60

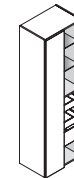

H. 144 - 168 - 192 - 218
- 235
L. 60

P. 51

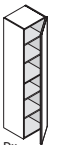

P. P. 51
H. 192 - 235
L. 45 - 60

P. 69,5

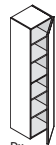

P. P. 69.5
H. 192 - 235
L. 45 - 60

COLONNE BORDO DRITTO

Modularità
Modularity
Modularité
Modularidad

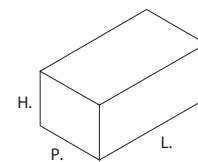

COLONNE A TERRA BORDO DRITTO CON CASSETTI / CESTONI
 FLOOR-STANDING TALL UNITS STRAIGHT EDGE WITH DRAWERS AND DEEP DRAWERS
 COLONNES AU SOL CHANT DROIT AVEC TIROIRS ET COULISSANTS
 COLUMNAS A SUELO CANTO RECTO CON CAJONES Y GAVETAS

P. 45,5

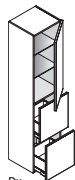

Dx
H. 192 - 235
L. 30 - 45 - 60

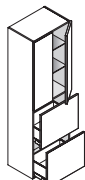

H. 192 - 235
L. 60

P. 51

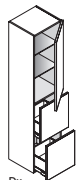

Dx
H. 192 - 235
L. 30 - 45 - 60

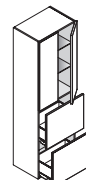

H. 192 - 235
L. 60

P. 69,5

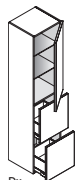

Dx
H. 192 - 235
L. 30 - 45 - 60

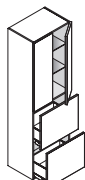

H. 192 - 235
L. 60

COLONNE BORDO DRITTO LAVANDERIA
 TALL UNITS LAUNDRY WITH STRAIGHT EDGE
 COLONNES LESSIVE AVEC CHANT DROIT
 COLUMNAS ROPA SUCIA CON CANTO RECTO

P. 51

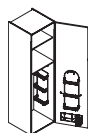

Dx
P. P. 51
H. 192 - 235
L. 45 - 60

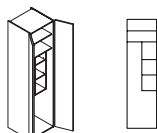

P. P. 51
H. 192 - 235
L. 60

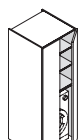

P. P. 51
H. 192 - 235
L. 75

P. 69,5

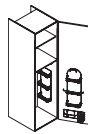

Dx
P. P. 69.5
H. 192 - 235
L. 45 - 60

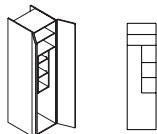

P. P. 69.5
H. 192 - 235
L. 60

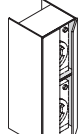

P. P. 69.5
H. 192 - 235
L. 75

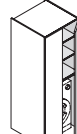

P. P. 69.5
H. 192 - 235
L. 75

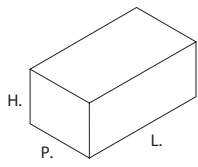

COLONNE A GIORNO
TALL UNITS OPEN
COLONNES OUVERT
COLUMNAS ABIERTO

P. 36,7



H. 144 - 168 - 192 - 218
- 235
L. 15 - 30

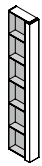

H. 144 - 168 - 192 - 218
- 235
L. 15

P. 45,5



H. 144 - 168 - 192 - 218
- 235
L. 15 - 30

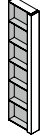

H. 144 - 168 - 192 - 218
- 235
L. 15

P. 51



H. 192 - 235
L. 15 - 30

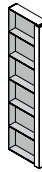

H. 192 - 235
L. 15

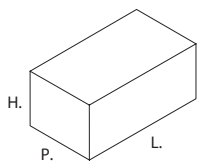

COLONNE BORDO 45°
TALL UNITS WITH 45° EDGES
COLONNES AVEC CHANT À 45°
COLUMNAS CON CANTO 45°

P. 22

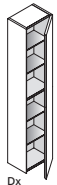

H. 144 - 168 - 192
L. 30 - 45

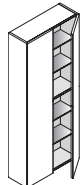

H. 144 - 168 - 192
L. 60

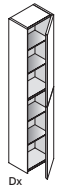

H. 144 - 168 - 192
L. 30 - 45

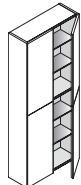

H. 144 - 168 - 192
L. 60

P. 42

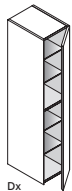

H. 144 - 168 - 192
L. 30 - 45

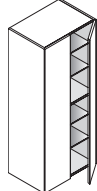

H. 144 - 168 - 192
L. 60

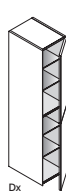

H. 144 - 168 - 192
L. 30 - 45

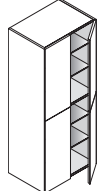

H. 144 - 168 - 192
L. 60

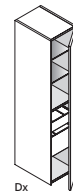

H. 144 - 168 - 192
L. 45

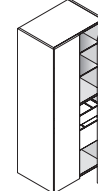

H. 144 - 168 - 192
L. 60

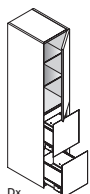

H. 144 - 168 - 192
L. 45

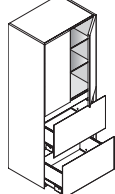

H. 144 - 168 - 192
L. 60

COLONNE ANGOLO

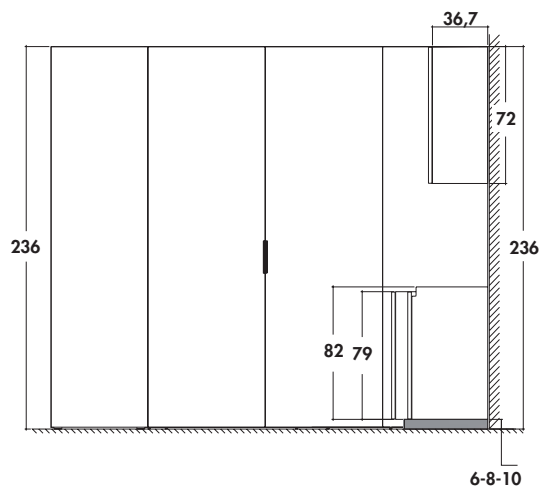

La cabina angolo H. 236 è consigliata con i pensili H. 72
The corner cabinet H. 236 is recommended with wall units H. 72
Le meuble d'angle H. 236 est recommandé avec les éléments hauts H. 72
Se recomienda el rinconero H. 236 con muebles altos H. 72

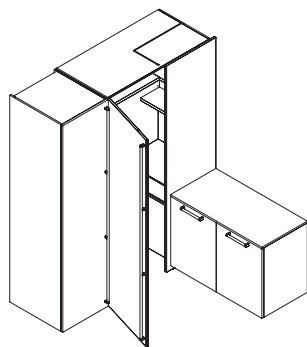

La cabina angolo può essere accostata a basi con zoccolo H. 6 / 8 / 10
Walk-in corner cabinet can be combined with base units with plinths H.6 / 8 / 10 cm
La cabine d'angle peut être associée avec des éléments bas avec plinthes H.6 / 8 / 10.
El mueble esquinero se puede combinar con muebles bajos con un zócalo de 6 / 8 / 10 H

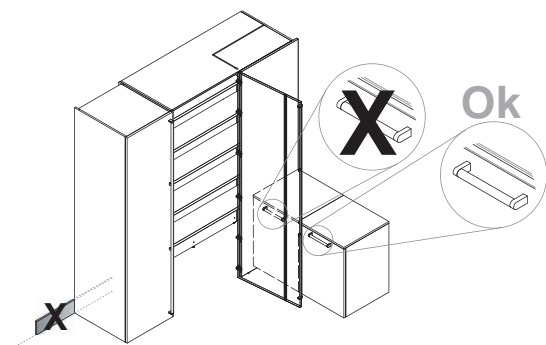

La cabina angolo è regolabile in altezza max 2,5 cm agendo sui piedini a scomparsa
The height of the walk-in corner cabinet could be adjusted by 2,5cm, acting on the concealed legs
La cabine d'angle est livrée avec pieds réglables jusqu'à 2,5 cm
El mueble esquinero se puede regular en altura hasta 2,5 cm actuando sobre las patas ocultas

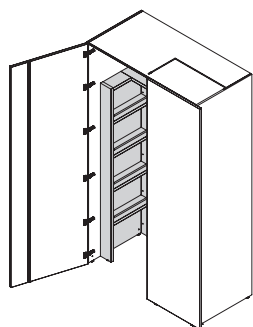

La cabina angolo lavaggio se non accostata ad altre colonne richiede inserimento elemento Tower
If the washing corner cabinet is not combined with other tall units, it requires the insertion of the Tower element
Si le meuble d'angle de lavage n'est pas combiné avec d'autres meubles hauts, il nécessite l'insertion de l'élément Tower
Si el mueble esquinero no se combina con otras columnas, se debe insertar el elemento Tower