COLLEZIONE

OPERA

altamarea®

BATHROOM
BOUTIQUE

FENIX NTM®

Finiture
Finishes
Finition
Acabados

MODO
LYMPHA
LYMPHA_MONOLITE
360 GRADI
360 GRADI +
OPERA
MUST

FENIX NTM®

FENIX NTM® - - FENIX NTM® - - FENIX NTM®

F1



Bianco Kos



Grigio Londra



Nero Ingo

F2

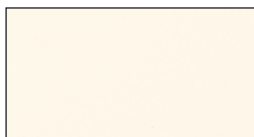

Bianco Malè



Beige Arizona



Castoro Ottawa

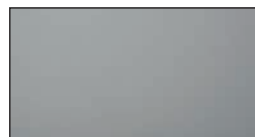

Grigio Antrim



Grigio Bromo



Verde Comodoro



Rosso Jaipur



Grigio Aragona



Blu Shaba

N.B. Attenzione colori indicativi, consultare mazzetta campioni finiture.

NOTE: Colours are indicative, please refer to the finish samples

Attention : les photos des coloris sont indicatifs, vérifiez le bon coloris dans les échantillons

N.B.: Atención colores orientativos, consultar muestrario de acabados.

LACCATO

Finiture
Finishes
Finition
Acabados

MODO
LYMPHA
LYMPHA_MONOLITE
360 GRADI
360 GRADI +
OPERA
MUST

LACCATO
LACQUERED - - LAQUÉ - - LACADO

Ossidato
Ossidato • Oxydé • Oxidado

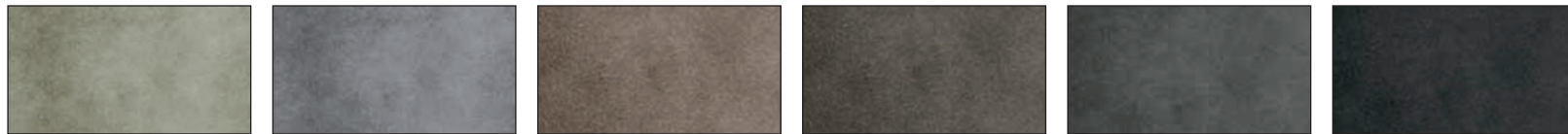

Gold Ghisa Ottone Bronzo Acciaio Piombo

Sand / Lucido
Sand / High gloss • Sand / Brillant • mate/brillo

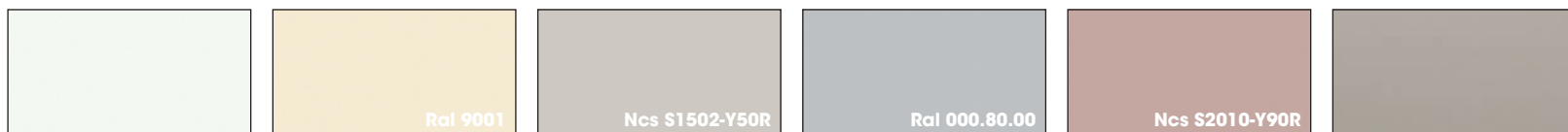

Bianco Puro Bianco Perla Mandorla Grigio Chiaro Cipria Argilla

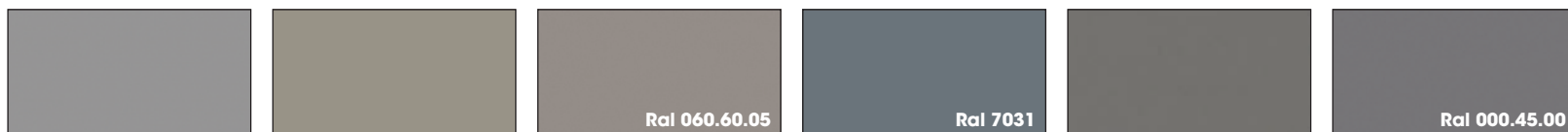

Grigio Fine Castoro Ottawa Arena Grigio Blu Grigio Londra Grigio Medio



Grigio Fango Grigio Marrone Ardesia Nero Petrolio



Tiffany Rosmarino Verde Acido Aston Rosso Vino Jaipur

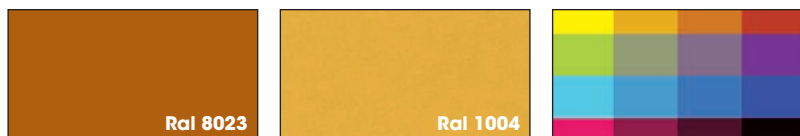

Marrone Arancio Giallo Ambra RAL / NCS ▲

▲ Per laccato a riferimento RAL o NCS addebito di € 150,00 per colore
The surcharge for RAL or NCS laquered colours is € 150,00 for each colour
Pour la laque RAL ou NCS rajouter € 150,00 euros par couleur.
Para lacados RAL o NCS sobreprecio de € 150,00 por color

N.B. Attenzione colori indicativi, consultare mazzetta campioni finiture.
NOTE: Colours are indicative, please refer to the finish samples
Attention : les photos des coloris sont indicatifs, vérifiez le bon coloris dans les échantillons
N.B.: Atención colores orientativos, consultar muestrario de acabados.

ROVERE

Finiture
Finishes
Finition
Acabados

MODO
LYMPHA
LYMPHA_MONOLITE
360 GRADI
360 GRADI +
OPERA
MUST

ROVERE VENATURA VERTICALE

OAK - VERTICAL GRAIN - CHÊNE - VEINAGE VERTICAL - ROBLE VETA VERTICAL



Rovere Laccato Bianco

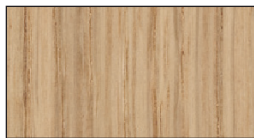

Rovere Chiaro

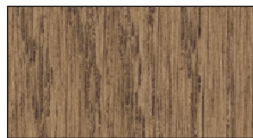

Rovere Tostato

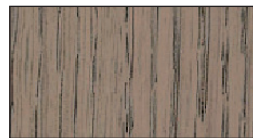

Rovere Atlas



Rovere Cacao

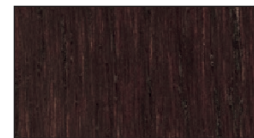

Rovere Scuro

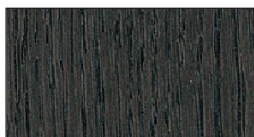

Rovere Savana



Rovere Laccato Nero

N.B. Attenzione colori indicativi, consultare mazzetta campioni finiture.

NOTE: Colours are indicative, please refer to the finish samples

Attention : les photos des coloris sont indicatifs, vérifiez le bon coloris dans les échantillons

N.B.: Atención colores orientativos, consultar muestrario de acabados.

ESSENZE

Finiture
Finishes
Finition
Acabados

MODO
LYMPHA
LYMPHA_MONOLITE
360 GRADI
360 GRADI +
OPERA
MUST

ESSENZE VENATURA VERTICALE

VENEERED WOODEN FINISHES - VERTICAL GRAIN - FINITIONS BOIS - VEINAGE VERTICAL - ACABADOS MADERA VETA VERTICAL



Sabbiato Amalfi

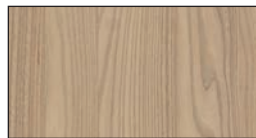

Olmo Naturale

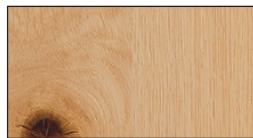

Rovere Nodino Chiaro

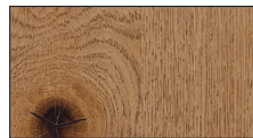

Rovere Nodino Tostato

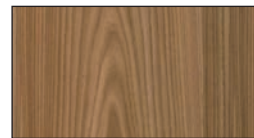

Olmo Termocotto

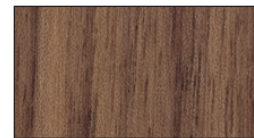

Noce Canaletto



Sabbiato Cortina

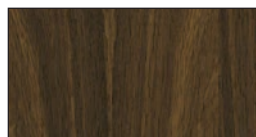

Rovere Termocotto

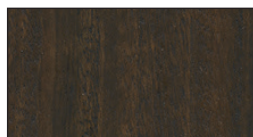

Eucalipto Termocotto

N.B. Attenzione colori indicativi, consultare mazzetta campioni finiture.

NOTE: Colours are indicative, please refer to the finish samples

Attention : les photos des coloris sont indicatifs, vérifiez le bon coloris dans les échantillons

N.B.: Atención colores orientativos, consultar muestrario de acabados.

OPERA

Informazioni tecniche

Technical information
Informations techniques
Notas técnicas

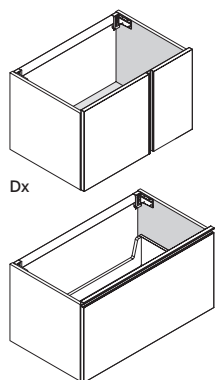

BASE REGGILAVABO SOSPESA

Frontali e fianchi a vista (inclusi nel prezzo)
• Laccato Sand / Lucido / Ossidato
• Fenix NTM®
• Rovere / Essenze

Scocca
• Pannello melaminico sp. 1,8 cm finitura bianco o grafite
• Schiena in finitura bianco o grafite sp. 0,5 cm

Maniglia integrata in verticale / orizzontale

Attaccaglie in acciaio regolabili con barra di rinforzo in alluminio, portata max 120 kg.

HANGING WASHBASIN UNIT

Visible fronts and sides (included in the price)
• Sand lacquered / Glossy / Oxidised
• Fenix NTM®
• Oak / Woods

Carcase
• 1.8 cm thick melamine panel white or graphite
• 0,5 cm thick back panel white or graphite

Integrated handle Vertical / Horizontal

St. Steel adjustable brackets with aluminum reinforcement bar. Maximum loading capacity 120 kg.

BAS POUR LAVABO SUSPENDU

Façades et côtés finis (compris dans le prix)
• Laqué Sand / brillant / oxydé
• Fenix NTM®
• Chêne / Bois

Caisson
• Panneau mélaminé ép. 1,8 cm finition blanc ou graphite
• Dos en finition blanc ou graphite ép. 0,5 cm

Poignée verticale / horizontale

Accroches en acier réglables avec barre de renfort en aluminium, portée max. 120 kg.

MUEBLE PARA LAVABO COLGANTE

Frentes y laterales vistos (incluidos en el precio)
• Lacado Sand / brillo / oxidado
• Fenix NTM®
• Roble / Maderas

Bastidor
• Panel en melamina esp. 1,8 cm acabado blanco o grafite
• Traserá en acabado blanco o grafite esp. 0,5 cm

tirador integrado vertical / horizontal

Soportes en acero ajustables con barra de refuerzo en aluminio, capacidad max. 120 kg

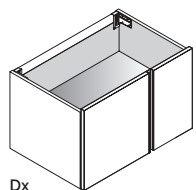

BASE ARREDO SOSPESA

Materiali, finiture e maniglie come base reggilavabo sospesa
• Schiena in finitura bianco o grafite sp. 0,5 cm
• Maniglia integrata in verticale / orizzontale

Attaccaglie in acciaio regolabili con barra di rinforzo in alluminio, portata max 120 kg.

WALL HANGING BASE UNIT

Materials and finishes are the same as the suspended washbasin units
• 0,5 cm thick back panel white or graphite
• Integrated handle Vertical / Horizontal

St. Steel adjustable brackets with aluminum reinforcement bar. Maximum loading capacity 120 kg.

MEUBLE BAS SUSPENDU

Matériaux et finitions comme pour bas porte-vasque suspendu
• Dos en finition blanc ou graphite ép. 0,5 cm
• Poignée verticale / horizontale

Accroches en acier réglables avec barre de renfort en aluminium, portée max. 120 kg.

MUEBLE BASE COLGANTE

Materiales y acabados como mueble para lavabo
• Traserá en acabado blanco o grafite esp. 0,5 cm
• tirador integrado vertical / horizontal

Soportes en acero ajustables con barra de refuerzo en aluminio, capacidad max. 120 kg

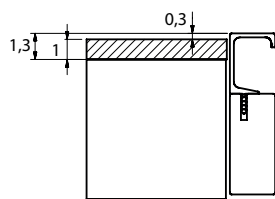

SPORGENZA MANIGLIA/TOP

Top in:
• Vetro
• Metallo Verniciato
• Laccato Sand / Lucido / Ossidato
• Rovere
• Essenze
Con top spessore 1 cm la maniglia sporge di 0,3 cm

Protrusion Handle/Top

Top in:
• Glass
• Painted metal
• Sand lacquered / Glossy / Oxidised
• Oak
• Veneered wooden finishes
With tops th. 1cm. handle sticks out by 0,3cm

DÉPASSEMENT ENTRE POIGNÉE ET PLAN

Plan en:
• Verre
• Métal laqué
• Laqué Sand / brillant / oxydé
• Chêne
• Finitions bois
plan épaisseur 1 cm : poignée saillante 0,3 cm

PROYECCIÓN TIRADOR/ENCIMERA

encimera en:
• Cristal
• Metal barnizado
• Lacado Sand / brillo / oxidado
• Roble
• Acabados madera
Con encimera de 1 cm de grosor, el tirador sobresale 0,3 cm

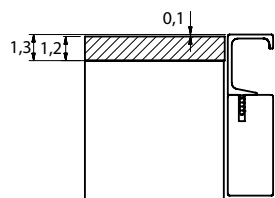

SPORGENZA MANIGLIA/TOP

Top in:
• Gres
• Korál
• Corian®
• Fenix NTM® Unicolor
• Silestone®
• Mineral
Con top spessore 1,2 cm la maniglia sporge di 0,1 cm

Protrusion Handle/Top

Top in:
• Ceramic
• Korál
• Corian®
• Fenix NTM® Unicolor
• Silestone®
• Mineral
With tops th. 1,2cm. handle sticks out by 0,1cm

DÉPASSEMENT ENTRE POIGNÉE ET PLAN

Plan en:
• Grès cérame
• Korál
• Corian®
• Fenix NTM® Unicolor
• Silestone®
• Mineral
plan épaisseur 1,2 cm : poignée saillante 0,1 cm

PROYECCIÓN TIRADOR/ENCIMERA

encimera en:
• Gres
• Korál
• Corian®
• Fenix NTM® Unicolor
• Silestone®
• Mineral
Con encimera de 1,2 cm de grosor, el tirador sobresale 0,1 cm

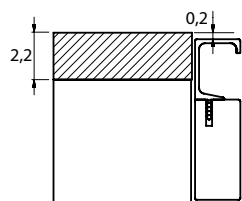

SPORGENZA MANIGLIA/TOP

Top in:
• Laccato Sand / Lucido / Ossidato
• Rovere
• Essenze
Con top spessore 2,2 cm la maniglia sporge di 0,2 cm

Protrusion Handle/Top

Top in:
• Sand lacquered / Glossy / Oxidised
• Oak
• Veneered wooden finishes
With tops th. 2,2cm. handle sticks out by 0,2cm

DÉPASSEMENT ENTRE POIGNÉE ET PLAN

Plan en:
• Laqué Sand / brillant / oxydé
• Chêne
• Finitions bois
plan épaisseur 2,2 cm : poignée saillante 0,2 cm

PROYECCIÓN TIRADOR/ENCIMERA

encimera en:
• Lacado Sand / brillo / oxidado
• Roble
• Acabados madera
Con encimera de 2,2 cm de grosor, el tirador sobresale 0,2 cm

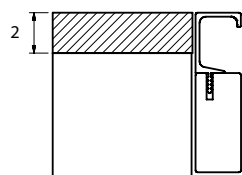

SPORGENZA MANIGLIA/TOP

Top in:
• Pietra / Marmo
Con top spessore 2 cm la maniglia non sporge rispetto al top

Protrusion Handle/Top

Top in:
• Stone - Marble
With tops th. 2cm. handle does not protrude

DÉPASSEMENT ENTRE POIGNÉE ET PLAN

Plan en:
• Pierre - Marbre
plan épaisseur 2 cm : poignée et plan afféurants

PROYECCIÓN TIRADOR/ENCIMERA

encimera en:
• Piedra - Marmol
Con encimera de 2 cm de grosor, el tirador no sobresale de la encimera

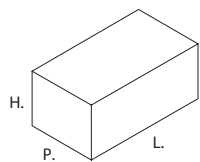

BASE REGGILAVABO
BASE REGGILAVABO
BASE REGGILAVABO
BASE REGGILAVABO

H. 24

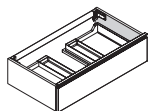

P. P. 42.5 - 51
L. L. 60 - 75 - 90 - 105
- 120

H. 36

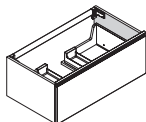

P. P. 42.5 - 51
L. L. 60 - 75 - 90 - 105
- 120

H. 48

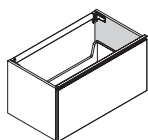

P. P. 42.5 - 51
L. L. 60 - 75 - 90 - 105
- 120

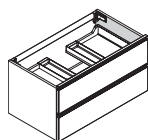

P. P. 42.5 - 51
L. L. 60 - 75 - 90 - 105
- 120

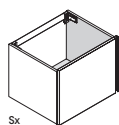

P. P. 42.5 - 51
L. L. 60

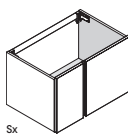

P. P. 42.5 - 51
L. L. 60 - 75 - 90

H. 60

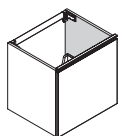

P. P. 42.5 - 51
L. L. 60

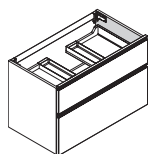

P. P. 42.5 - 51
L. L. 60 - 75 - 90 - 105
- 120

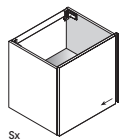

P. P. 42.5 - 51
L. L. 60

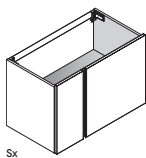

P. P. 42.5 - 51
L. L. 60 - 75 - 90 - 105

OPERA

Modularità
Modularity
Modularité
Modularidad

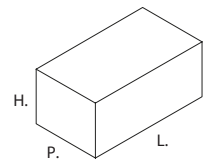

BASE ARREDO
BASE ARREDO
BASE ARREDO
BASE ARREDO

H. 24

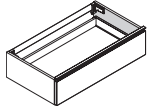

P. P. 42.5 - 51
L. L. 30 - 45 - 60 - 75 - 90 -
105 - 120

H. 36

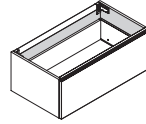

P. P. 42.5 - 51
L. L. 30 - 45 - 60 - 75 - 90 -
105 - 120

H. 48

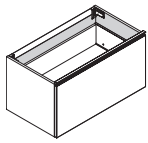

P. P. 42.5 - 51
L. L. 30 - 45 - 60 - 75 - 90 -
105 - 120

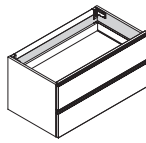

P. P. 42.5 - 51
L. L. 30 - 45 - 60 - 75 - 90 -
105 - 120

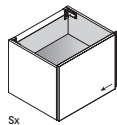

P. P. 42.5 - 51
L. L. 30 - 45 - 60

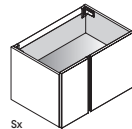

P. P. 42.5 - 51
L. L. 45 - 60 - 75 - 90

H. 60

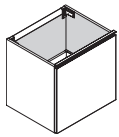

P. P. 42.5 - 51
L. L. 60

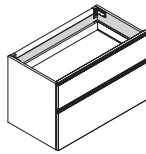

P. P. 42.5 - 51
L. L. 30 - 45 - 60 - 75 - 90

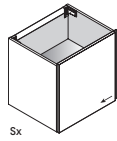

P. P. 42.5 - 51
L. L. 30 - 45 - 60

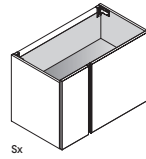

P. P. 42.5 - 51
L. L. 45 - 60 - 75 - 90 - 105

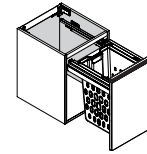

P. P. 51
L. L. 45

CARRELLI
CARRELLI
CARRELLI
CARRELLI

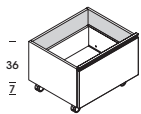

P. P. 42 - 51
H. L. 43
L. L. 60 - 75 - 90

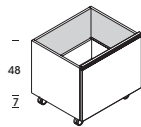

P. P. 42 - 51
H. L. 55
L. L. 60 - 75 - 90

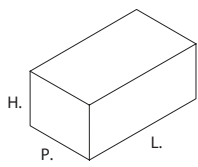

PENSILI BORDO DRITTO
WALL UNITS WITH STRAIGHT EDGE
AVEC CHANT DROIT
MUEBLES ALTO CON CANTO RECTO

P. 21,2

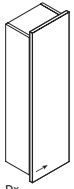

H. 48 - 60 - 72 - 96 - 120
- 144 - 168
L. 30

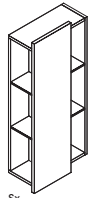

H. 72 - 96 - 120 - 144
- 168
L. 45

P. 19

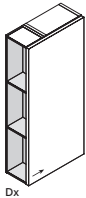

H. 48 - 60 - 72 - 96 - 120
L. 45 - 60

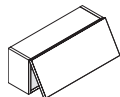

H. 24 - 36
L. 60 - 75 - 90 - 105 -
120

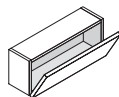

H. 24 - 36
L. 60 - 75 - 90 - 105 -
120



H. 48 - 60 - 72 - 96 - 120
L. 30 - 45 - 60

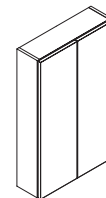

H. 48 - 60 - 72 - 96 - 120
L. 60 - 90



H. 48 - 60 - 72 - 96 - 120
L. 30 - 45

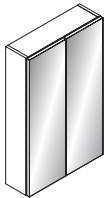

H. 48 - 60 - 72 - 96 - 120
L. 60 - 90

P. 36,7

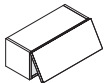

H. 24 - 36
L. 60 - 75 - 90 - 105 -
120

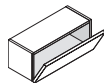

H. 24 - 36
L. 60 - 75 - 90 - 105 -
120



H. 48 - 60 - 72 - 96 - 120
L. 30 - 45

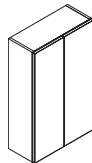

H. 48 - 60 - 72 - 96 - 120
L. 60 - 90



H. 48 - 60 - 72 - 96 - 120
L. 30 - 45

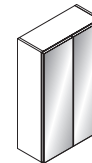

H. 48 - 60 - 72 - 96 - 120
L. 60 - 90

P. 69,5

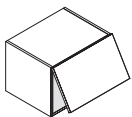

H. 36 - 48 - 60
L. 45 - 60 - 75 - 90

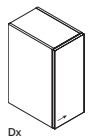

H. 48 - 60
L. 45 - 60

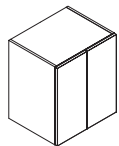

H. 48 - 60
L. 90

PENSILI BORDO DRITTO

Modularità
Modularity
Modularité
Modularidad

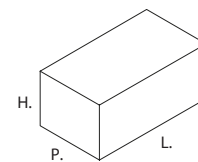

PENSILI A GIORNO WALL UNITS OPEN ÉLÉMENTS HAUTS OUVERT MUEBLES ALTO ABIERTO

P. 19



H. 24
L. 30 - 45 - 60

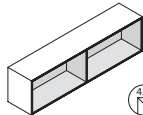

H. 24
L. 75 - 90 - 105 - 120

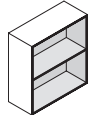

H. 36 - 48 - 60 - 72
L. 30 - 45 - 60



H. 24 - 36 - 48 - 60 - 72
L. 15÷30 - 30,1÷45

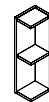

H. 36 - 48 - 60 - 72 - 96
- 120
L. 15 - 30

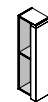

H. 36 - 48 - 60 - 72 - 96
- 120
L. 15

P. 36,7

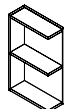

P. P. 36.7
H. 36 - 48 - 63 - 72 - 120
L. 15 - 30



P. P. 36.7
H. 36 - 48 - 63 - 72 - 96 - 120
L. 15

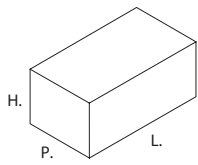

PENSILI BORDO 45°

WALL UNITS WITH 45° EDGES
ÉLÉMENTS HAUTS AVEC CHANT À 45°
MUEBLES ALTO CON CANTO 45°

P. 22

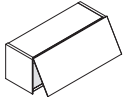

H. 24 - 36
L. 45 - 60 - 75 - 90



H. 48 - 60 - 72 - 96 - 120
L. 30 - 45 - 60

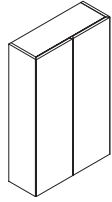

H. 48 - 60 - 72 - 96 - 120
L. 60 - 90



H. 48 - 60 - 72 - 96 - 120
L. 30 - 45 - 60

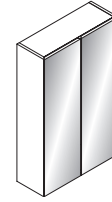

H. 48 - 60 - 72 - 96 - 120
L. 60 - 90

PENSILI A GIORNO CON BORDI 45°

WALL UNITS OPEN WITH 45° EDGES
ÉLÉMENTS HAUTS OUVERTS AVEC CHANT À 45°
MUEBLES ALTO ABIERTOS CON CANTO 45°

P. 22

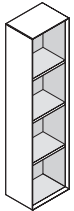

H. 24 - 36 - 48 - 60 - 72 -
96 - 120 - 144 - 168 - 192
L. 30 - 45 - 15

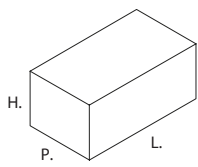

COLONNE SOSPESSE BORDO DRITTO
TALL UNITS SUSPENDED WITH STRAIGHT EDGE
COLONNES SUSPENDUES AVEC CHANT DROIT
COLUMNAS SUSPENDIDAS CON CANTO RECTO

P. 19

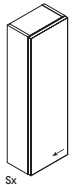

H. 144 - 168 - 192
L. 30 - 45 - 60

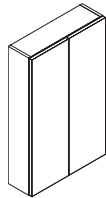

H. 144 - 168 - 192
L. 60



H. 144 - 168 - 192
L. 30 - 45 - 60

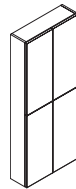

H. 144 - 168 - 192
L. 60

COLONNE A TERRA BORDO DRITTO CON ANTA
FLOOR-STANDING TALL UNITS STRAIGHT EDGE WITH DOORS
COLONNES AU SOL CHANT DROIT AVEC PORTE
COLUMNAS A SUELO CANTO RECTO CON PUERTA

P. 36,7

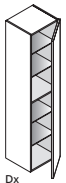

H. 144 - 168 - 192 - 218
- 235
L. 30 - 45 - 60

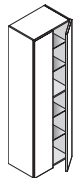

H. 144 - 168 - 192 - 218
- 235
L. 60



H. 144 - 168 - 192 - 235
L. 30 - 45 - 60

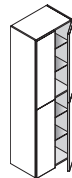

H. 144 - 168 - 192 - 235
L. 60

P. 45,5

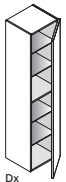

H. 144 - 168 - 192 - 218
- 235
L. 30 - 45 - 60

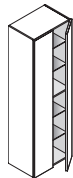

H. 144 - 168 - 192 - 218
- 235
L. 60

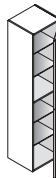

H. 144 - 168 - 192 - 235
L. 30 - 45 - 60

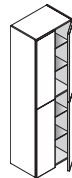

H. 144 - 168 - 192 - 235
L. 60

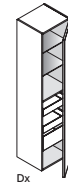

H. 144 - 168 - 192 - 218
- 235
L. 45 - 30 - 60

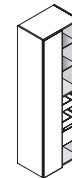

H. 144 - 168 - 192 - 218
- 235
L. 60

P. 51

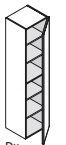

P. P. 51
H. 192 - 235
L. 45 - 60

P. 69,5

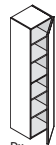

P. P. 69.5
H. 192 - 235
L. 45 - 60

COLONNE BORDO DRITTO

Modularità
Modularity
Modularité
Modularidad

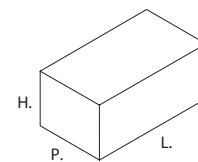

COLONNE A TERRA BORDO DRITTO CON CASSETTI / CESTONI
 FLOOR-STANDING TALL UNITS STRAIGHT EDGE WITH DRAWERS AND DEEP DRAWERS
 COLONNES AU SOL CHANT DROIT AVEC TIROIRS ET COULISSANTS
 COLUMNAS A SUELO CANTO RECTO CON CAJONES Y GAVETAS

P. 45,5

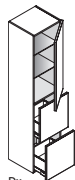

Dx
H. 192 - 235
L. 30 - 45 - 60

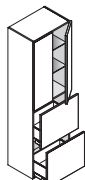

H. 192 - 235
L. 60

P. 51

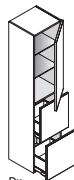

Dx
H. 192 - 235
L. 30 - 45 - 60

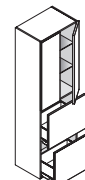

H. 192 - 235
L. 60

P. 69,5

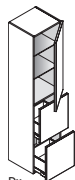

Dx
H. 192 - 235
L. 30 - 45 - 60

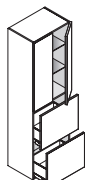

H. 192 - 235
L. 60

COLONNE BORDO DRITTO LAVANDERIA
 TALL UNITS LAUNDRY WITH STRAIGHT EDGE
 COLONNES LESSIVE AVEC CHANT DROIT
 COLUMNAS ROPA SUCIA CON CANTO RECTO

P. 51



Dx
P. P. 51
H. 192 - 235
L. 45 - 60

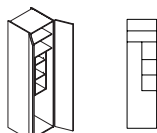

P. P. 51
H. 192 - 235
L. 60

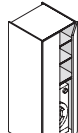

P. P. 51
H. 192 - 235
L. 75

P. 69,5

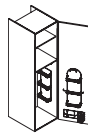

Dx
P. P. 69.5
H. 192 - 235
L. 45 - 60

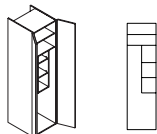

P. P. 69.5
H. 192 - 235
L. 60

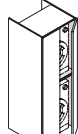

P. P. 69.5
H. 192 - 235
L. 75

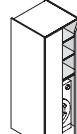

P. P. 69.5
H. 192 - 235
L. 75

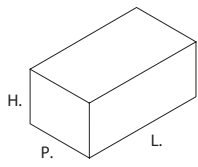

COLONNE A GIORNO
TALL UNITS OPEN
COLONNES OUVERT
COLUMNAS ABIERTO

P. 36,7



H. 144 - 168 - 192 - 218
- 235
L. 15 - 30

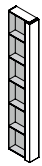

H. 144 - 168 - 192 - 218
- 235
L. 15

P. 45,5

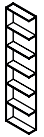

H. 144 - 168 - 192 - 218
- 235
L. 15 - 30

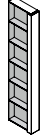

H. 144 - 168 - 192 - 218
- 235
L. 15

P. 51



H. 192 - 235
L. 15 - 30

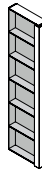

H. 192 - 235
L. 15

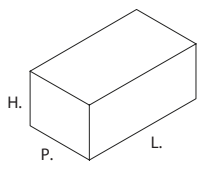

COLONNE BORDO 45°
TALL UNITS WITH 45° EDGES
COLONNES AVEC CHANT À 45°
COLUMNAS CON CANTO 45°

P. 22

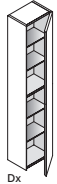

Dx

H. 144 - 168 - 192
L. 30 - 45

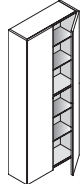

Dx

H. 144 - 168 - 192
L. 60

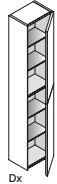

Dx

H. 144 - 168 - 192
L. 30 - 45

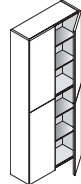

Dx

H. 144 - 168 - 192
L. 60

P. 42



Dx

H. 144 - 168 - 192
L. 30 - 45

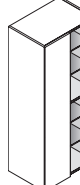

Dx

H. 144 - 168 - 192
L. 60



Dx

H. 144 - 168 - 192
L. 30 - 45



Dx

H. 144 - 168 - 192
L. 60

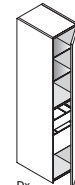

Dx

H. 144 - 168 - 192
L. 45

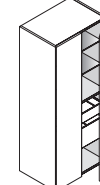

Dx

H. 144 - 168 - 192
L. 60

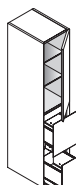

Dx

H. 144 - 168 - 192
L. 45

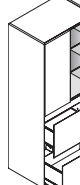

Dx

H. 144 - 168 - 192
L. 60

COLONNE ANGOLO

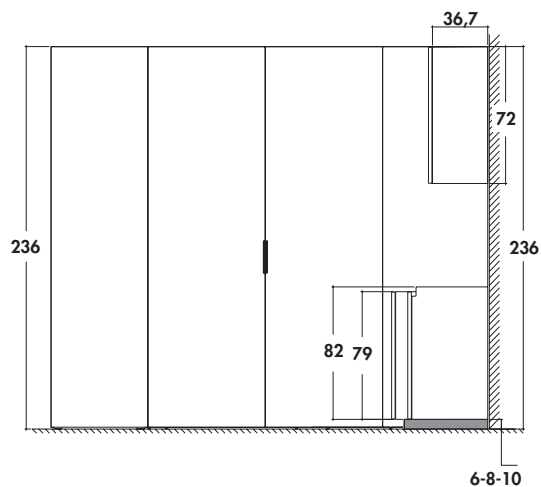

La cabina angolo H. 236 è consigliata con i pensili H. 72
The corner cabinet H. 236 is recommended with wall units H. 72
Le meuble d'angle H. 236 est recommandé avec les éléments hauts H. 72
Se recomienda el rinconero H. 236 con muebles altos H. 72

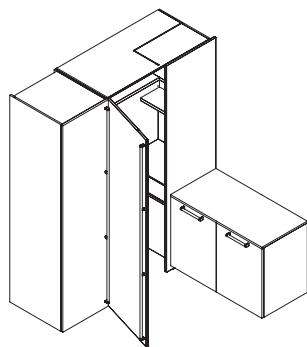

La cabina angolo può essere accostata a basi con zoccolo H. 6 / 8 / 10
Walk-in corner cabinet can be combined with base units with plinths H.6 / 8 / 10 cm
La cabine d'angle peut être associée avec des éléments bas avec plinthes H.6 / 8 / 10.
El mueble esquinero se puede combinar con muebles bajos con un zócalo de 6 / 8 / 10 H

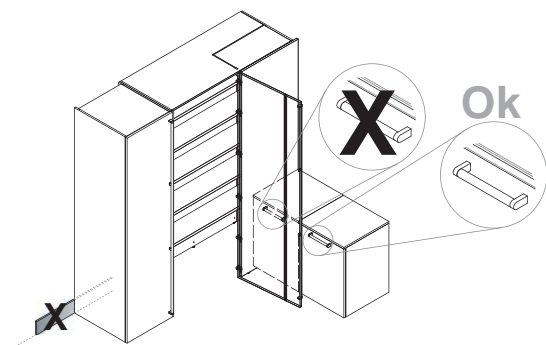

La cabina angolo è regolabile in altezza max 2,5 cm agendo sui piedini a scomparsa
The height of the walk-in corner cabinet could be adjusted by 2,5cm, acting on the concealed legs
La cabine d'angle est livrée avec pieds réglables jusqu'à 2,5 cm
El mueble esquinero se puede regular en altura hasta 2,5 cm actuando sobre las patas ocultas

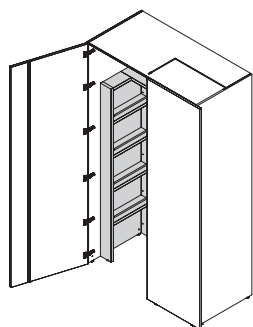

La cabina angolo lavaggio se non accostata ad altre colonne richiede inserimento elemento Tower
If the washing corner cabinet is not combined with other tall units, it requires the insertion of the Tower element
Si le meuble d'angle de lavage n'est pas combiné avec d'autres meubles hauts, il nécessite l'insertion de l'élément Tower
Si el mueble esquinero no se combina con otras columnas, se debe insertar el elemento Tower