

---

COLLEZIONE

# 360 GRADI

**altamarea®**

BATHROOM  
BOUTIQUE

---

# FENIX NTM®

Finiture  
Finishes  
Finition  
Acabados

MODO  
LYMPHA  
LYMPHA\_MONOLITE  
360 GRADI  
360 GRADI +  
OPERA  
MUST

FENIX NTM®  
FENIX NTM® - - FENIX NTM® - - FENIX NTM®

## F1



Bianco Kos



Grigio Londra



Nero Ingo

## F2

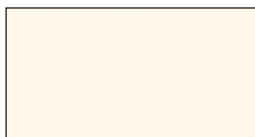

Bianco Malè



Beige Arizona



Castoro Ottawa

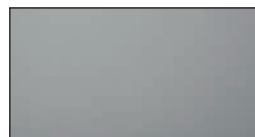

Grigio Antrim



Grigio Bromo



Verde Comodoro



Rosso Jaipur

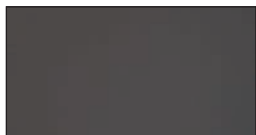

Grigio Aragona



Blu Shaba

**N.B. Attenzione colori indicativi, consultare mazzetta campioni finiture.**

*NOTE: Colours are indicative, please refer to the finish samples*

*Attention : les photos des coloris sont indicatifs, vérifiez le bon coloris dans les échantillons*

*N.B.: Atención colores orientativos, consultar muestrario de acabados.*

# LACCATO

Finiture  
Finishes  
Finition  
Acabados

MODO  
LYMPHA  
LYMPHA\_MONOLITE  
360 GRADI  
360 GRADI +  
OPERA  
MUST

LACCATO  
LACQUERED - - LAQUÉ - - LACADO

Ossidato  
Ossidato • Oxydé • Oxidado

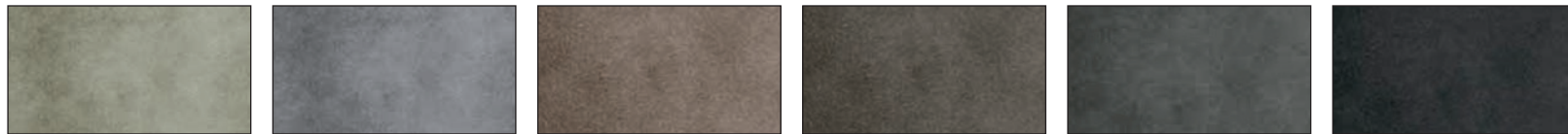

Gold Ghisa Ottone Bronzo Acciaio Piombo

Sand / Lucido  
Sand / High gloss • Sand / Brillant • mate/brillo

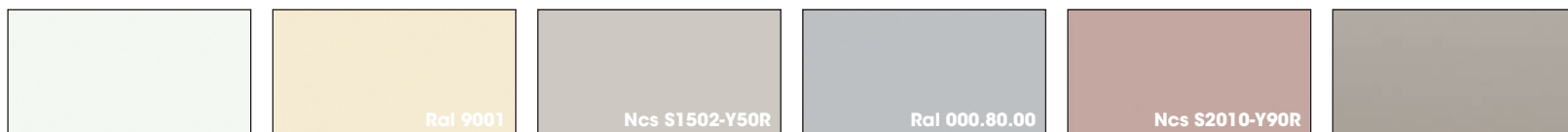

Bianco Puro Bianco Perla Mandorla Grigio Chiaro Cipria Argilla

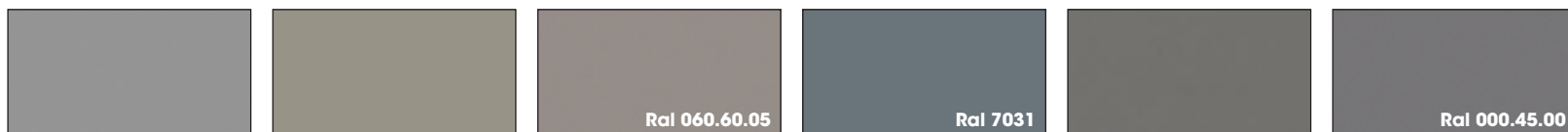

Grigio Fine Castoro Ottawa Arena Grigio Blu Grigio Londra Grigio Medio

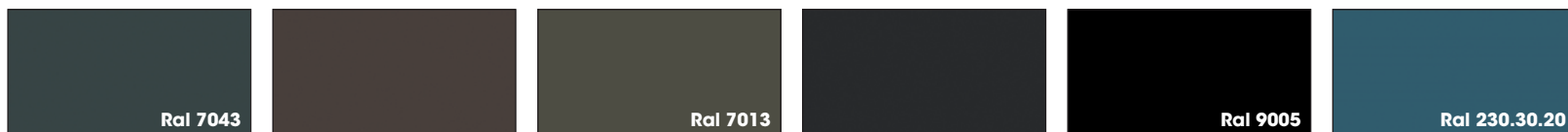

Grigio Fango Grigio Marrone Ardesia Nero Petrolio



Tiffany Rosmarino Verde Acido Aston Rosso Vino Jaipur

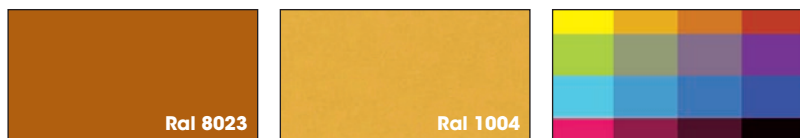

Marrone Arancio Giallo Ambra RAL / NCS ▲

▲ Per laccato a riferimento RAL o NCS addebito di € 150,00 per colore  
The surcharge for RAL or NCS laquered colours is € 150,00 for each colour  
Pour la laque RAL ou NCS rajouter € 150,00 euros par couleur.  
Para lacados RAL o NCS sobreprecio de € 150,00 por color

N.B. Attenzione colori indicativi, consultare mazzetta campioni finiture.  
NOTE: Colours are indicative, please refer to the finish samples  
Attention : les photos des coloris sont indicatifs, vérifiez le bon coloris dans les échantillons  
N.B.: Atención colores orientativos, consultar muestrario de acabados.

# ROVERE

Finiture  
Finishes  
Finition  
Acabados

MODO  
LYMPHA  
LYMPHA\_MONOLITE  
360 GRADI  
360 GRADI +  
OPERA  
MUST

## ROVERE VENATURA VERTICALE

OAK - VERTICAL GRAIN - CHÊNE - VEINAGE VERTICAL - ROBLE VETA VERTICAL



Rovere Laccato Bianco

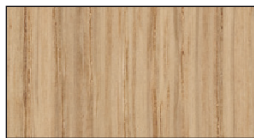

Rovere Chiaro

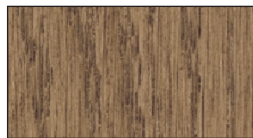

Rovere Tostato



Rovere Atlas



Rovere Cacao

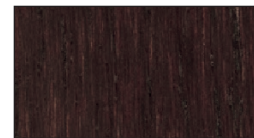

Rovere Scuro

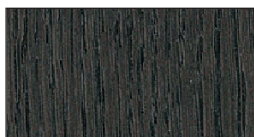

Rovere Savana



Rovere Laccato Nero

**N.B. Attenzione colori indicativi, consultare mazzetta campioni finiture.**

*NOTE: Colours are indicative, please refer to the finish samples*

*Attention : les photos des coloris sont indicatifs, vérifiez le bon coloris dans les échantillons*

*N.B.: Atención colores orientativos, consultar muestrario de acabados.*

# ESSENZE

Finiture  
Finishes  
Finition  
Acabados

MODO  
LYMPHA  
LYMPHA\_MONOLITE  
360 GRADI  
360 GRADI +  
OPERA  
MUST

## ESSENZE VENATURA VERTICALE

VENEERED WOODEN FINISHES - VERTICAL GRAIN - FINITIONS BOIS - VEINAGE VERTICAL - ACABADOS MADERA VETA VERTICAL



Sabbiato Amalfi

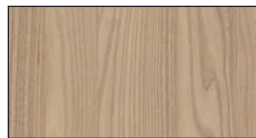

Olmo Naturale

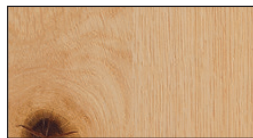

Rovere Nodino Chiaro

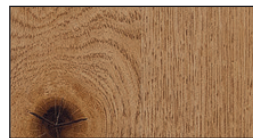

Rovere Nodino Tostato



Olmo Termocotto

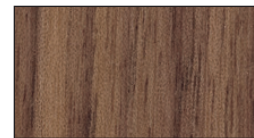

Noce Canaletto



Sabbiato Cortina

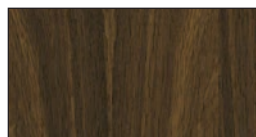

Rovere Termocotto

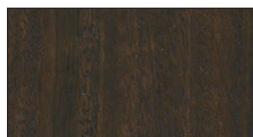

Eucalipto Termocotto

**N.B. Attenzione colori indicativi, consultare mazzetta campioni finiture.**

*NOTE: Colours are indicative, please refer to the finish samples*

*Attention : les photos des coloris sont indicatifs, vérifiez le bon coloris dans les échantillons*

*N.B.: Atención colores orientativos, consultar muestrario de acabados.*

---

**PARQUET**  
PARQUET - - PARQUET - - PARQUET

---



Atelier Siena 1348 ▲  
18900192 €/mq 330



Listoni Del Cliente

▲ **Il prezzo di listino non comprende il listone prefinito (No massello) di parquet che viene fornito dal Cliente in conto lavoro: mq di superficie da rivestire x 2**

**N.B. I lati interni sono realizzati in finitura Rovere**

*Price does not include the pre-finished parquet plank (No solid wood) which is provided by the Customer: square meter to clad x 2*

*NOTE: internal faces are made of Oak*

*Le prix en tarif ne comprend pas les planchers parquet préfinis (pas en bois massif) qui doivent être fournis par le client à titre de travail à façon. Quantité de parquet à fournir : m2 de surface à revêtir fois 2.*

*N.B. cotés internes en finition chêne*

*El precio de tarifa no incluye la lama de parquet precabada (no madera maciza) que suministra el Cliente en régimen de subcontratación: m2 de superficie a cubrir x 2*

*N.B.: Los laterales internos están realizados en acabado Roble*

---

**N.B. Attenzione colori indicativi, consultare mazzetta campioni finiture.**

*NOTE: Colours are indicative, please refer to the finish samples*

*Attention : les photos des coloris sont indicatifs, vérifiez le bon coloris dans les échantillons*

*N.B.: Atención colores orientativos, consultar muestrario de acabados.*

---

# VETRO

Finiture  
Finishes  
Finition  
Acabados

MODULO  
LYMPHA  
LYMPHA-MONILITE  
**360 GRADI**  
360 GRADI  
OPERA  
MUST

## VETRO SP.4 MM

GLASS - TH.4MM - VERRE - ÈPA MM - CRISTAL GR. 6 MM

### Lucido / Acidato

Polished / Etched • Brillant / Dépoli acide • brillo / acidado

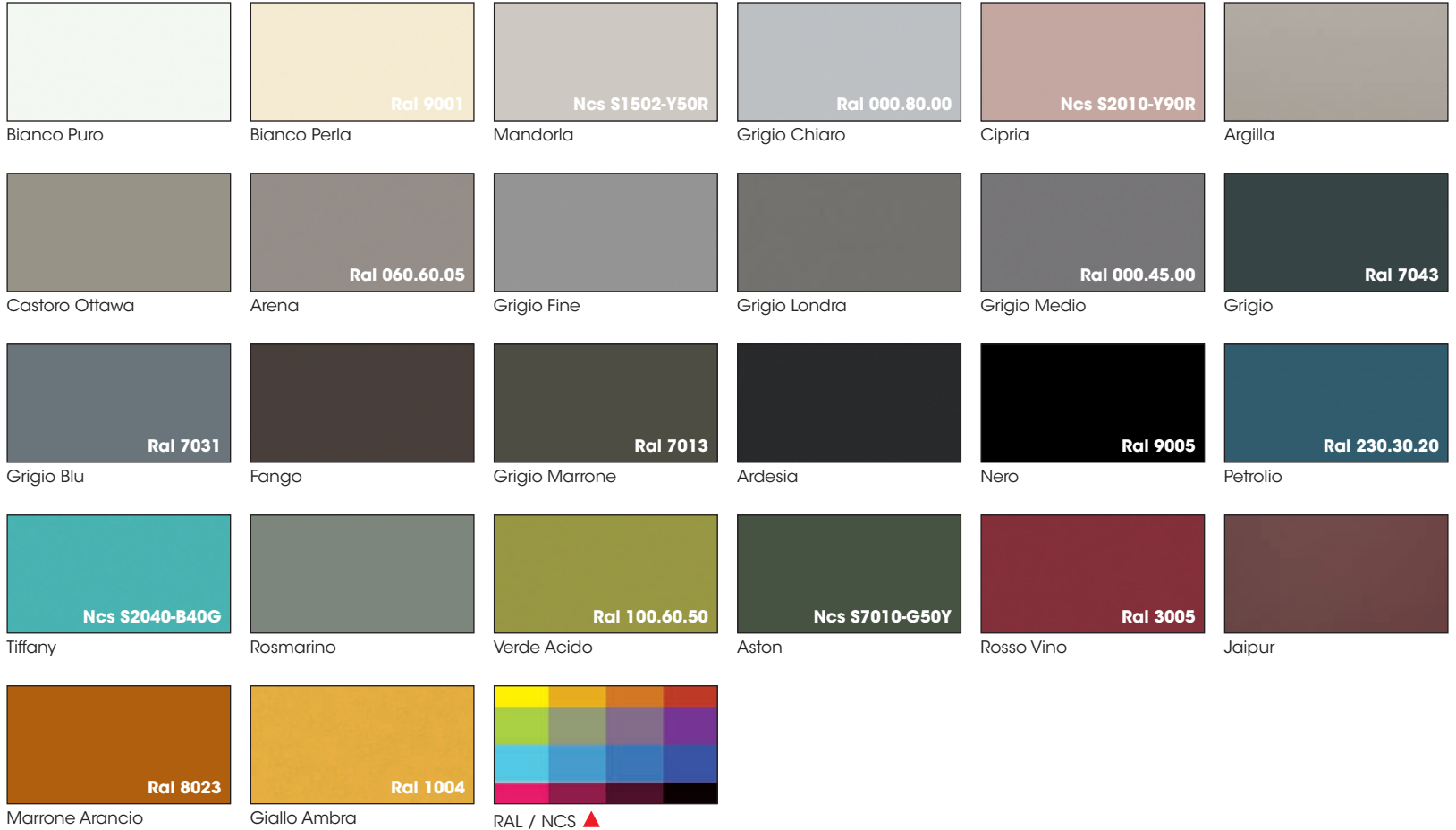

▲ **Per laccato a riferimento RAL o NCS addebito di € 150,00 per colore**  
*The surcharge for RAL or NCS laquered colours is € 150,00 for each colour*  
*Pour la laque RAL ou NCS rajouter € 150,00 euros par couleur.*  
*Para lacados RAL o NCS sobreprecio de € 150,00 por color*

**N.B. Attenzione colori indicativi, consultare mazzetta campioni finiture.**  
*NOTE: Colours are indicative, please refer to the finish samples*  
*Attention : les photos des coloris sont indicatifs, vérifiez le bon coloris dans les échantillons*  
*N.B.: Atención colores orientativos, consultar muestrario de acabados.*

# GRES

Finiture  
Finishes  
Finition  
Acabados

MODO  
LYMPHA  
LYMPHA-MONILITE  
**360 GRADI**  
360 GRADI  
OPERA  
MUST

**GRES**  
CERAMIC - - GRÈS CÉRAME - - GRES

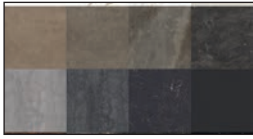

Gres Cliente (SOLO OPACO) ▲  
Conto lavoro

▲ **Maggiorazione di 550€ per ritiro cassa di gres: ritiro SOLO da magazzini Italia.**  
*Surcharge of 550€ for pick-up client's gres on wooden crate: ONLY from warehouses located in Italy*  
*Supplément de 550€ pour retirer les pieces en céramique auprès d'un fabricant (uniquement dans le territoire Italien)*  
*Recargo de 550 € por recogida de cajas de porcelanico: recogida SOLO en almacenes italianos.*

## Florim® - Sp. 6 mm

Florim® - th.6mm • Florim® - ép. 6 mm • Florim® - 6 mm de grosor

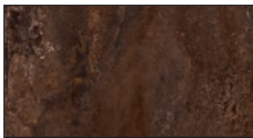

Metal Russet  
★ Ardesia

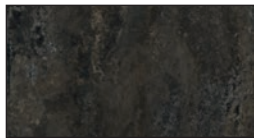

Metal Burnished  
★ Ardesia

## Inalco® - Sp. 6 mm

Inalco® - Th. 6 mm • Inalco® - ép. 6 mm • Inalco® - 6 mm de grosor

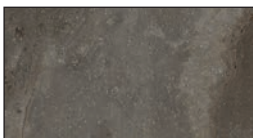

Vint Gris  
★ Grigio Londra

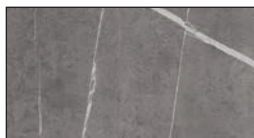

Senda Gris  
★ Grigio Fine

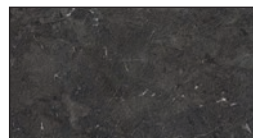

Umbra Marron Bocciardato  
★ Ardesia



Azalci Nero  
★ Nero



Nero Assoluto Liscio  
★ Nero

## Kerlite® - Sp. 5,5 mm

Kerlite® - Th. 5,5 mm • Kerlite® - ép. 5,5 mm • Kerlite® - 5,5 mm de grosor

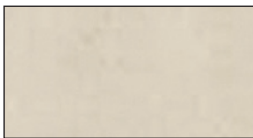

Via Condotti  
★ Mandorla



Via Tornabuoni  
★ Argilla



Via Farini  
★ Castoro Ottawa

## Laminam® - Sp. 5,5 mm

Laminam® - Th. 5,5 mm • Laminam® - ép. 5,5 mm • Laminam® - 5,5 mm de grosor

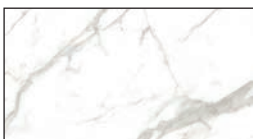

Calacatta Oro Venato  
★ Bianco Perla



Bianco Statuario Venato  
★ Mandorla

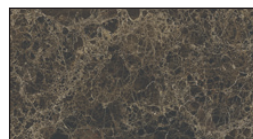

Emperador Extra  
★ Ardesia

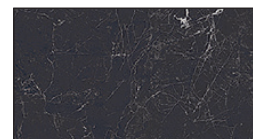

Nero Greco  
★ Ardesia

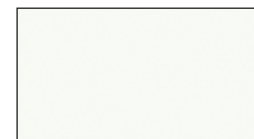

Bianco Assoluto  
★ Bianco Puro



Savoia Perla  
★ Mandorla

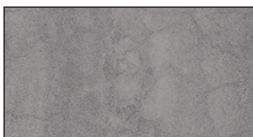

Savoia Grigio  
★ Grigio Fine

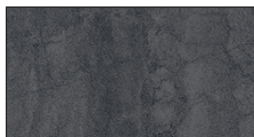

Savoia Antracite  
★ Grigio 7043

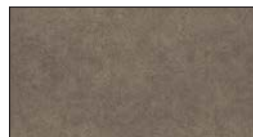

Fokos Roccia  
★ Grigio Londra



Fokos Terra  
★ Castoro Ottawa

**N.B. Attenzione colori indicativi, consultare mazzetta campioni finiture. - Colore scocca / Gola: abbinamento consigliato per il colore scocca e gola**

*NOTE: Colours are indicative, please refer to the finish samples - Body / Groove colour: recommended combination for the body and groove colour*

*Attention : les photos des coloris sont indicatifs, vérifiez le bon coloris dans les échantillons - Couleur du corps/rainure : combinaison recommandée pour la couleur du corps et de la rainure*

*N.B.: Atención colores orientativos, consultar muestrario de acabados. - Color del cuerpo / ranura: combinación recomendada para el color del cuerpo y la ranura*



# METALLO OSSIDATO

Finiture  
Finishes  
Finition  
Acabados

MODO  
LYMPHA  
LYMPHA-MONILITE  
**360 GRADI**  
360 GRADI  
OPERA  
**MUST**

## METALLO OSSIDATO SP. 1 MM

OXIDISED METAL - TH. 1MM - MÉTAL OXYDÉ - ÉP.1 MM - METAL OXIDADO GR. 1 MM



Acciaio Nuvolato  
\* Ardesia



Ottone Nuvolato  
\* Grigio Marrone

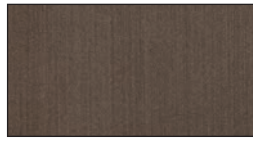

Bronzo Dark  
\* Ardesia



Rame Silver  
\* Fango



Zinc  
\* Grigio Marrone



Gold  
\* Castoro Ottawa

**N.B. Attenzione colori indicativi, consultare mazzetta campioni finiture. - Colore scocca / Gola: abbinamento consigliato per il colore scocca e gola \***

*NOTE: Colours are indicative, please refer to the finish samples - Body / Groove colour: recommended combination for the body and groove colour \**

*Attention : les photos des coloris sont indicatifs, vérifiez le bon coloris dans les échantillons - Couleur du corps/rainure : combinaison recommandée pour la couleur du corps et de la rainure \**

*N.B.: Atención colores orientativos, consultar muestrario de acabados. - Color del cuerpo / ranura: combinación recomendada para el color del cuerpo y la ranura \**

MODO—  
LYMPHA—  
LYMPHA-MONILITE—  
**360 GRADI**  
360 GRADI+  
OPERA—  
MUST—

**CORIAN®**

**Finiture**  
Finishes  
Finition  
Acabados

---

**CORIAN® SP.4 MM**

CORIAN® - TH.4MM - CORIAN® - ÈP4 MM - CORIAN® GR. 6 MM

---

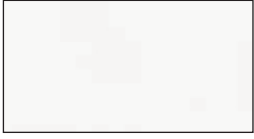

Glacier White  
\* Bianco Puro

---

**N.B. Attenzione colori indicativi, consultare mazzetta campioni finiture. - Colore scocca / Gola: abbinamento consigliato per il colore scocca e gola \***

*NOTE: Colours are indicative, please refer to the finish samples - Body / Groove colour: recommended combination for the body and groove colour \**

*Attention : les photos des coloris sont indicatifs, vérifiez le bon colori dans les échantillons - Couleur du corps/rainure : combinaison recommandée pour la couleur du corps et de la rainure \**

*N.B.: Atención colores orientativos, consultar muestrario de acabados. - Color del cuerpo / ranura: combinación recomendada para el color del cuerpo y la ranura \**

---

# 360 GRADI

**Informazioni tecniche**  
*Technical information*  
*Informations techniques*  
*Notas técnicas*

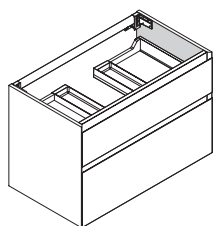

## BASE REGGILAVABO SOSPESA

Fondo, fianco intermedio e gola in pannello  
 • Pannello mdf laccato Sp. 1,8 cm con lavorazione a 45°  
 • Pannello impiallacciato Sp. 1,8 cm

Frontali e fianco a vista in:  
 • Pannello mdf laccato Sp. 1,8 cm con lavorazione a 45°  
 • Pannello rivestito lato esterno in Fenix NTM® e lato interno in tinta Sp. 1,8 cm con lavorazione a 45°  
 • Pannello impiallacciato Sp. 1,8 cm con lavorazione a 45°  
 • Pannello laccato con rivestimento in vari materiali su lato esterno e interno laccato in tinta Sp. da 1,9 cm a 2,4 cm con lavorazione a 45°

Attaccaglie in acciaio regolabili con barra di rinforzo in alluminio, portata max 120 kg.

## HANGING WASHBASIN UNIT

Bottom, intermediate side panel and channel in  
 • 1,8 cm thick MDF lacquered panel  
 • 1,8 cm thick veneered panel

Fronts and sides in view:  
 • 1,8 cm thick MDF panel with 45° chamfering  
 • 1,8 cm thick panel with 45° chamfering, clad in Fenix Ntm on the visible side, and laminate to match on the internal side.  
 • 1,8 cm thick wood veneered panel with 45° chamfering  
 • Lacquered panel with external covering in various materials and internal side lacquered in the same color. Thicknesses from 1,9 to 2,4 cm and 45° chamfering

St. Steel adjustable brackets with aluminum reinforcement bar. Maximum loading capacity 120 kg.

## BAS POUR LAVABO SUSPENDU

Fond, joue intermédiaire et gorge en panneau  
 • Panneau mdf laqué ép. 1,8 cm  
 • Panneau plaqué ép. 1,8 cm

Façades et joues visibles en:  
 • Panneau mdf laqué ép. 1,8 cm avec usinage à 45°  
 • Panneau habillé côté externe en Fenix Ntm et côté interne stratifié dans la même couleur ép. 1,8 cm et usinage à 45°  
 • Panneau plaqué ép. 1,8 cm avec usinage à 45°  
 • Panneau laqué avec revêtement en divers matériaux sur les côtés extérieur et intérieur laqué de la même couleur ép. de 1,9 à 2,4 cm avec usinage à 45°

Accroches en acier réglables avec barre de renfort en aluminium, portée max. 120 kg.

## MUEBLE PARA LAVABO COLGANTE

Fondo, costado intermedio y gola en panel  
 • Panel mdf lacado esp. 1,8 cm  
 • Panel chapado esp. 1,8 cm

Frente y costado en vista  
 • Panel mdf lacado esp. 1,8 cm con junta a 45°  
 • Panel revestido Fenix Ntm en el lado exterior y en el lado interior laminado en color esp. 18 mm con junta a 45°  
 • Panel chapado esp. 1,8 cm con junta a 45°  
 • Panel con revestimiento en varios materiales en el lado exterior e interior lacado color esp. De 1,9 a 2,4 cm con junta a 45°

Soportes en acero ajustables con barra de refuerzo en aluminio, capacidad max. 120 kg

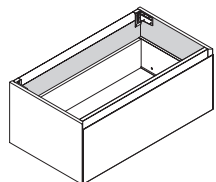

## BASE ARREDO SOSPESA

Materiali, finiture e maniglie come base reggilavabo sospesa  
 • Schiena in finitura laccato o impiallacciato Sp. 0,5 cm  
 • Schiena in finitura Fenix NTM® Sp. 1 cm

Attaccaglie in acciaio regolabili con barra di rinforzo in alluminio, portata max 120 kg.

## WALL HANGING BASE UNIT

Materials and finishes are the same as the suspended washbasin units  
 • 0,5 cm thick back panel available in lacquers or wood veneers finishes  
 • Fenix Ntm back panel 1 cm thick

St. Steel adjustable brackets with aluminum reinforcement bar. Maximum loading capacity 120 kg.

## MEUBLE BAS SUSPENDU

Matériaux et finitions comme pour bas porte-vasque suspendu  
 • Dos en finition laquée ou plaqué ép. 0,5 cm  
 • Dos en finition Fenix Ntm ép. 1 cm

Accroches en acier réglables avec barre de renfort en aluminium, portée max. 120 kg.

## MUEBLE BASE COLGANTE

Materiali e acabados como mueble para lavabo  
 • Trasera en acabado lacado o chapado esp. 0,5 cm  
 • trasera en acabado Fenix Ntm esp. 1 cm

Soportes en acero ajustables con barra de refuerzo en aluminio, capacidad max. 120 kg

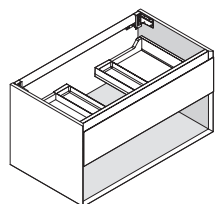

## BASE REGGILAVABO SOSPESA CON VANO A GIORNO

Materiali e finiture come base reggilavabo sospesa  
 • Vano a giorno in finitura come i frontali con lavorazioni a 45°

Attaccaglie in acciaio regolabili con barra di rinforzo in alluminio, portata max 120 kg.

## SUSPENDED WASHBASIN UNIT WITH OPEN COMPARTMENT

Materials and finishes are the same as the suspended washbasin units  
 • Finished open shelf unit with 45° front chamfering

St. Steel adjustable brackets with aluminum reinforcement bar. Maximum loading capacity 120 kg.

## BAS POUR LAVABO AVEC ELEMENT A JOUR

Matériaux et finitions comme pour bas porte-vasque suspendu  
 • Meuble ouvert en finition comme les façades avec usinage à 45°

Accroches en acier réglables avec barre de renfort en aluminium, portée max. 120 kg.

## MUEBLE PARA LAVABO COLGANTE CON ELEMENTO ABIERTO

Materiali e acabados como mueble para lavabo  
 • Elemento abierto como frentes con junta a 45°

Soportes en acero ajustables con barra de refuerzo en aluminio, capacidad max. 120 kg

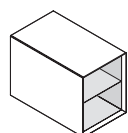

## BASE A GIORNO SOSPESA

Materiali e finiture come i frontali con lavorazioni a 45°

Attaccaglie a scomparsa con regolazione dall'interno

## WALL HANGING OPEN BASE UNIT

Materials and finishes as per door's fronts with 45° chamfering

Concealed and adjustable wall supports

## BAS OUVERT SUSPENDU

Matériaux et finitions comme les façades avec usinage à 45°

Accroches rétractables avec réglage de l'intérieur

## MUEBLE COLGANTE ABIERTO

Materiali e acabados como frentes con junta a 45°

Soportes ocultos que se ajustan desde el interior

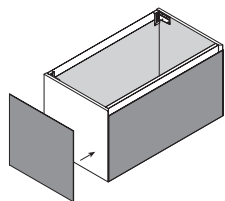

## RIVESTIMENTO DEL FIANCO

Rivestimento in vari materiali applicato su lato esterno e interno laccato in tinta con lavorazione a 45°

Disponibile nelle finiture  
 • Vetro Sp. 4 mm  
 • Gres Sp. 5,5/6 mm  
 • Metallo Ossidato Sp. 1 mm  
 • Corian® Sp. 4 mm  
 • Parquet

## SIDE PANEL'S CLADDING

External covering in various materials and internal side lacquered in the same color and with 45° chamfering

Available in finishes  
 • 4 mm thick glass  
 • Gres 5,5/6 mm thick  
 • Oxidised metal Th. 1 mm  
 • 4 mm thick Corian®  
 • Parquet

## REVÊTEMENT DU CÔTÉ

Revêtement dans les divers matériaux appliqué sur le côté externe et interne laqué dans la même couleur avec usinage à 45°

Disponibile dans les finitions  
 • Verre ép. 4 mm  
 • Gres ép. 5,5/6 mm  
 • Métal oxydé Ep. 1 mm  
 • Corian® ép. 4 mm  
 • Parquet

## REVESTIMIENTO DEL COSTADO

Revestimiento en varios materiales aplicado en el lado exterior e interior lacado en color con junta a 45°

Disponibile en los acabados  
 • Cristal esp. 4 mm  
 • Gres esp. 5,5/6 mm  
 • Metal oxidado Esp. 1 mm  
 • Corian® esp. 4 mm  
 • Parquet

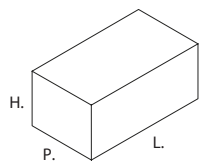

**BASE REGGILAVABO**  
WASHBASIN UNITS  
MEUBLE PAS PORTE-VASQUE  
MUEBLES LAVABOS

**H. 24**

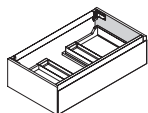

P. P. 42 - 50.5  
L. L. 60 - 75 - 90 - 105 - 120

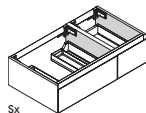

Sx  
P. P. 42 - 50.5  
L. L. 90 - 105 - 120 - 135

**H. 36**

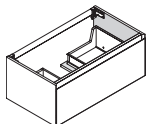

P. P. 42 - 50.5  
L. L. 60 - 75 - 90 - 105 - 120

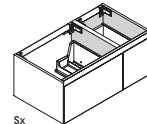

Sx  
P. P. 42 - 50.5  
L. L. 90 - 105 - 120 - 135

**H. 48**

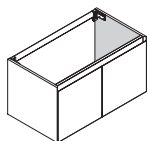

P. P. 42 - 50.5  
L. L. 60 - 90 - 120

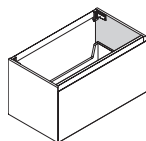

P. P. 42 - 50.5  
L. L. 60 - 75 - 90 - 105 - 120

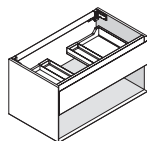

P. P. 42 - 50.5  
L. L. 60 - 75 - 90 - 105 - 120

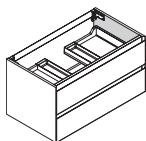

P. P. 42 - 50.5  
L. L. 60 - 75 - 90 - 105 - 120

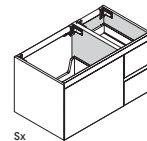

Sx  
P. P. 42 - 50.5  
L. L. 90 - 105 - 120 - 135

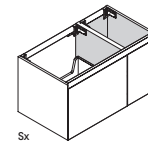

Sx  
P. P. 42 - 50.5  
L. L. 90 - 105 - 120 - 135

**H. 60**

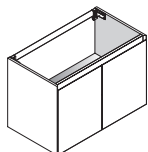

P. P. 42 - 50.5  
L. L. 60 - 90

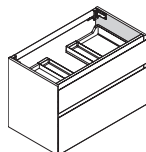

P. P. 42 - 50.5  
L. L. 60 - 75 - 90 - 105 - 120

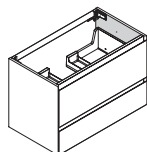

P. P. 42 - 50.5  
L. L. 60 - 75 - 90 - 105 - 120

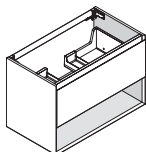

P. P. 42 - 50.5  
L. L. 60 - 75 - 90 - 105 - 120

**H. 72**

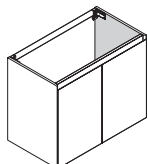

P. P. 42 - 50.5  
L. L. 60 - 90

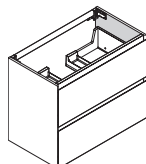

P. P. 42 - 50.5  
L. L. 60 - 75 - 90 - 105 - 120

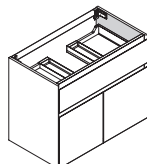

P. P. 42 - 50.5  
L. L. 60 - 90 - 120

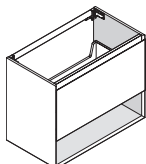

P. P. 42 - 50.5  
L. L. 60 - 75 - 90 - 105 - 120

# 360 GRADI

Modularità  
Modularity  
Modularité  
Modularidad

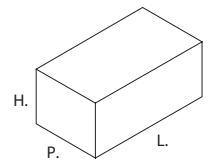

## BASE ARREDO UNIT BASE ÉLEMENT BAS MUEBLE BAJO

### H. 24

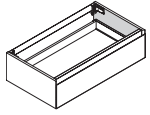

P. P. 42 - 50.5  
L. L. 30 - 45 - 60 - 75 - 90 -  
105 - 120

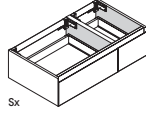

Sx  
P. P. 42 - 50.5  
L. L. 90 - 105 - 120 - 135

### H. 36

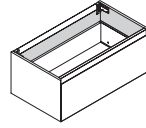

P. P. 42 - 50.5  
L. L. 30 - 45 - 60 - 75 - 90 -  
105 - 120

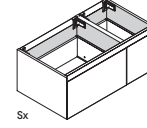

Sx  
P. P. 42 - 50.5  
L. L. 90 - 105 - 120 - 135

### H. 48

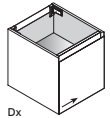

Dx  
P. P. 42 - 50.5  
L. L. 30 - 45

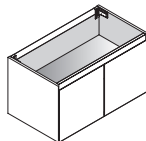

P. P. 42 - 50.5  
L. L. 60 - 90 - 120

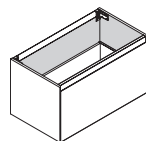

P. P. 42 - 50.5  
L. L. 30 - 45 - 60 - 75 - 90 -  
105 - 120

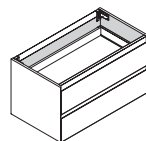

P. P. 42 - 50.5  
L. L. 30 - 45 - 60 - 75 - 90 -  
105 - 120

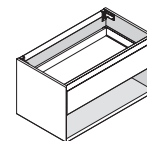

P. P. 42 - 50.5  
L. L. 30 - 45 - 60 - 75 - 90 -  
105 - 120

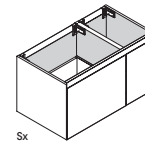

Sx  
P. P. 42 - 50.5  
L. L. 90 - 105 - 120 - 135

### H. 60

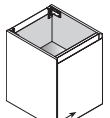

Dx  
P. P. 42 - 50.5  
L. L. 30 - 45

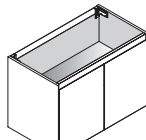

P. P. 42 - 50.5  
L. L. 60 - 90

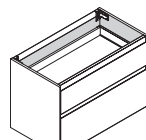

P. P. 42 - 50.5  
L. L. 30 - 45 - 60 - 75 - 90 -  
105 - 120

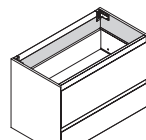

P. P. 42 - 50.5  
L. L. 30 - 45 - 60 - 75 - 90 -  
105 - 120

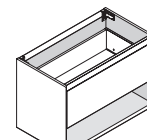

P. P. 42 - 50.5  
L. L. 30 - 45 - 60 - 75 - 90 -  
105 - 120

### H. 72

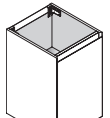

Dx  
P. P. 42 - 50.5  
L. L. 30 - 45

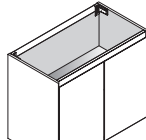

P. P. 42 - 50.5  
L. L. 60 - 90

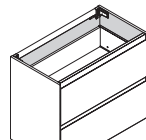

P. P. 42 - 50.5  
L. L. 30 - 45 - 60 - 75 - 90 -  
105 - 120

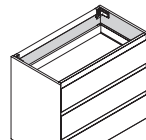

P. P. 42 - 50.5  
L. L. 30 - 45 - 60 - 75 - 90 -  
105 - 120

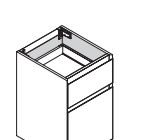

Dx  
P. P. 42 - 50.5  
L. L. 30 - 45

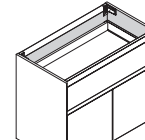

P. P. 42 - 50.5  
L. L. 60 - 90 - 120

### H. 88

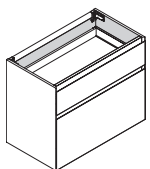

P. P. 42 - 50.5  
L. L. 30 - 45 - 60 - 75 - 90 -  
120

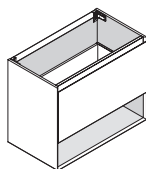

P. P. 42 - 50.5  
L. L. 60 - 75 - 90 - 105 -  
120

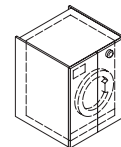

P. P. 50.5 - 69.5  
L. L. 75

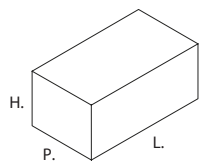

**ELEMENTI A GIORNO**  
OPEN SHELF UNITS  
MEUBLES OUVERTS  
ELEMENTOS ABIERTOS

**H. 24**



P. P. 42 - 50.5  
L. L. 15 - 30 - 45 - 60

**H. 36**



P. P. 42 - 50.5  
L. L. 15 - 30 - 45 - 60

**H. 48**

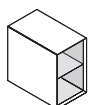

P. P. 42 - 50.5  
L. L. 15 - 30 - 45

**H. 60**

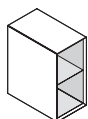

P. P. 42 - 50.5  
L. L. 15 - 30 - 45

**H. 72**

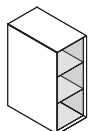

P. P. 42 - 50.5  
L. L. 15 - 30 - 45

**CARRELLI**  
TROLLEYS  
CHARIOTS  
CASTORO

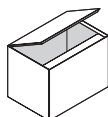

P. P. 42  
H. L. 34 - 46  
L. L. 60 - 75

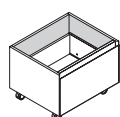

P. P. 42 - 50.5  
H. L. 43  
L. L. 60 - 75 - 90

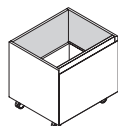

P. P. 42 - 50.5  
H. L. 55  
L. L. 60 - 75 - 90

---

COLLEZIONE

# 360 GRADI +

**altamarea®**

BATHROOM  
BOUTIQUE

---

# FENIX NTM®

Finiture  
Finishes  
Finition  
Acabados

MODO  
LYMPHA  
LYMPHA\_MONOLITE  
360 GRADI  
360 GRADI +  
OPERA  
MUST

## FENIX NTM®

FENIX NTM® - - FENIX NTM® - - FENIX NTM®

### F1



Bianco Kos



Grigio Londra



Nero Ingo

### F2

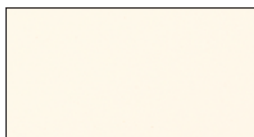

Bianco Malè



Beige Arizona



Castoro Ottawa

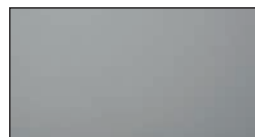

Grigio Antrim



Grigio Bromo

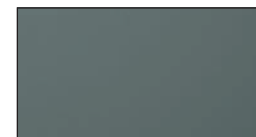

Verde Comodoro



Rosso Jaipur



Grigio Aragona



Blu Shaba

**N.B. Attenzione colori indicativi, consultare mazzetta campioni finiture.**

*NOTE: Colours are indicative, please refer to the finish samples*

*Attention : les photos des coloris sont indicatifs, vérifiez le bon coloris dans les échantillons*

*N.B.: Atención colores orientativos, consultar muestrario de acabados.*



# LACCATO

Finiture  
Finishes  
Finition  
Acabados

MODO  
LYMPHA  
LYMPHA\_MONOLITE  
360 GRADI  
360 GRADI +  
OPERA  
MUST

LACCATO  
LACQUERED - - LAQUÉ - - LACADO

Ossidato  
Ossidato • Oxydé • Oxidado

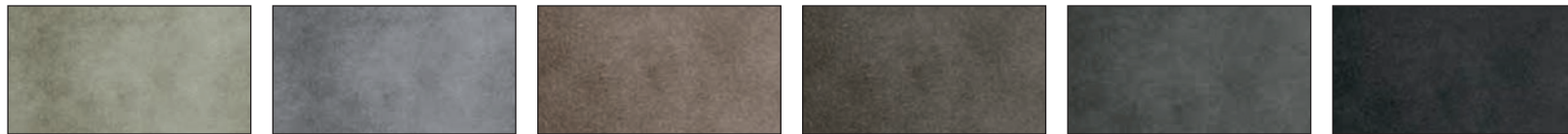

Gold Ghisa Ottone Bronzo Acciaio Piombo

Sand / Lucido  
Sand / High gloss • Sand / Brillant • mate/brillo

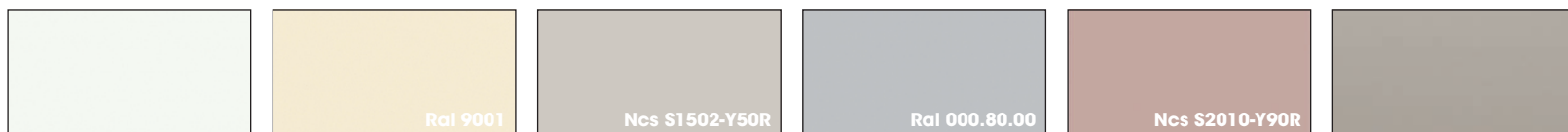

Bianco Puro Bianco Perla Mandorla Grigio Chiaro Cipria Argilla

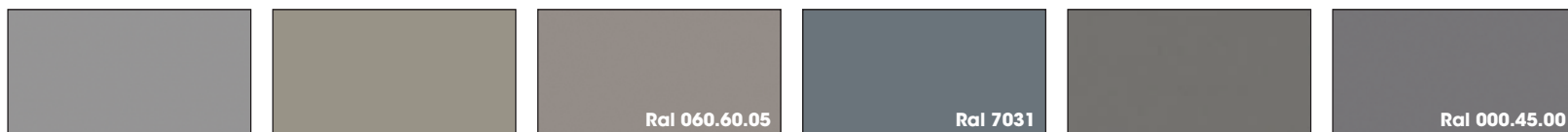

Grigio Fine Castoro Ottawa Arena Grigio Blu Grigio Londra Grigio Medio

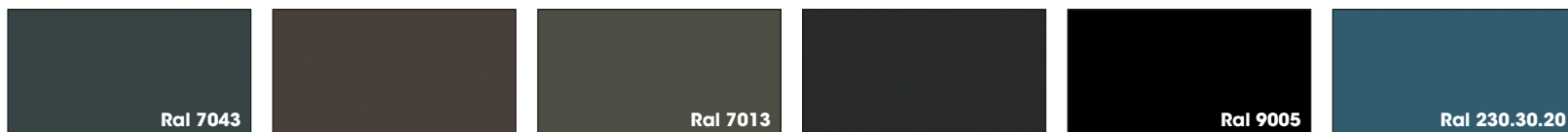

Grigio Fango Grigio Marrone Ardesia Nero Petrolio



Tiffany Rosmarino Verde Acido Aston Rosso Vino Jaipur

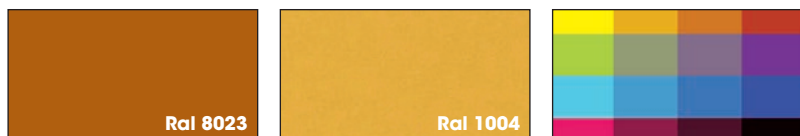

Marrone Arancio Giallo Ambra RAL / NCS ▲

▲ Per laccato a riferimento RAL o NCS addebito di € 150,00 per colore  
The surcharge for RAL or NCS laquered colours is € 150,00 for each colour  
Pour la laque RAL ou NCS rajouter € 150,00 euros par couleur.  
Para lacados RAL o NCS sobreprecio de € 150,00 por color

N.B. Attenzione colori indicativi, consultare mazzetta campioni finiture.  
NOTE: Colours are indicative, please refer to the finish samples  
Attention : les photos des coloris sont indicatifs, vérifiez le bon coloris dans les échantillons  
N.B.: Atención colores orientativos, consultar muestrario de acabados.

# ROVERE

Finiture  
Finishes  
Finition  
Acabados

MODO  
LYMPHA  
LYMPHA\_MONOLITE  
360 GRADI  
360 GRADI +  
OPERA  
MUST

## ROVERE VENATURA VERTICALE

OAK - VERTICAL GRAIN - CHÊNE - VEINAGE VERTICAL - ROBLE VETA VERTICAL



Rovere Laccato Bianco

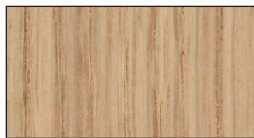

Rovere Chiaro

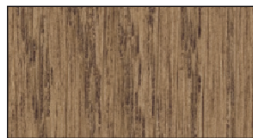

Rovere Tostato



Rovere Atlas



Rovere Cacao

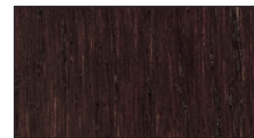

Rovere Scuro

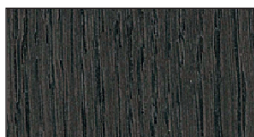

Rovere Savana



Rovere Laccato Nero

**N.B. Attenzione colori indicativi, consultare mazzetta campioni finiture.**

*NOTE: Colours are indicative, please refer to the finish samples*

*Attention : les photos des coloris sont indicatifs, vérifiez le bon coloris dans les échantillons*

*N.B.: Atención colores orientativos, consultar muestrario de acabados.*

# ESSENZE

## Finiture

Finishes

Finition

Acabados

MODO  
LYMPHA  
LYMPHA\_MONOLITE  
360 GRADI  
360 GRADI +  
OPERA  
MUST

## ESSENZE VENATURA VERTICALE

VENEERED WOODEN FINISHES - VERTICAL GRAIN - FINITIONS BOIS - VEINAGE VERTICAL - ACABADOS MADERA VETA VERTICAL



Sabbiato Amalfi



Olmo Naturale



Rovere Nodino Chiaro



Rovere Nodino Tostato



Olmo Termocotto



Noce Canaletto



Sabbiato Cortina



Rovere Termocotto



Eucalipto Termocotto

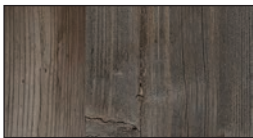

Abete Tabacco ▲  
SOLO LYMPHA\_MONOLITE

▲ **Disponibile solo per LYMPHA\_MONOLITE**  
*Only available for LYMPHA\_MONOLITE*  
*Disponible uniquement pour LYMPHA\_MONOLITE*  
*Disponibile solo para LYMPHA\_MONOLITE*

**N.B. Attenzione colori indicativi, consultare mazzetta campioni finiture.**

*NOTE: Colours are indicative, please refer to the finish samples*

*Attention : les photos des coloris sont indicatifs, vérifiez le bon coloris dans les échantillons*

*N.B.: Atención colores orientativos, consultar muestrario de acabados.*

**PARQUET**  
PARQUET - - PARQUET - - PARQUET



Atelier Siena 1348 ▲  
18900192 €/mq 330

Listoni Del Cliente

▲ **Il prezzo di listino non comprende il listone prefinito (No massello) di parquet che viene fornito dal Cliente in conto lavoro: mq di superficie da rivestire x 2**

**N.B. I lati interni sono realizzati in finitura Rovere**

*Price does not include the pre-finished parquet plank (No solid wood) which is provided by the Customer: square meter to clad x 2*

*NOTE: internal faces are made of Oak*

*Le prix en tarif ne comprend pas les planchers parquet préfinis (pas en bois massif) qui doivent être fournis par le client à titre de travail à façon. Quantité de parquet à fournir : m2 de surface à revêtir fois 2.*

*N.B. cotés internes en finition chêne*

*El precio de tarifa no incluye la lama de parquet precabada (no madera maciza) que suministra el Cliente en régimen de subcontratación: m2 de superficie a cubrir x 2*

*N.B.: Los laterales internos están realizados en acabado Roble*

**N.B. Attenzione colori indicativi, consultare mazzetta campioni finiture.**

*NOTE: Colours are indicative, please refer to the finish samples*

*Attention : les photos des coloris sont indicatifs, vérifiez le bon coloris dans les échantillons*

*N.B.: Atención colores orientativos, consultar muestrario de acabados.*



# 360 GRADI +

**Informazioni tecniche**  
Technical information  
Informations techniques  
Notas técnicas

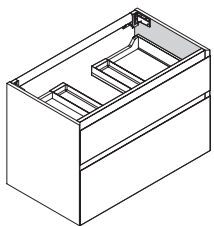

## BASE REGGILAVABO SOSPESA

Fondo, fianco intermedio e gola in pannello

- Pannello mdf laccato Sp. 1,8 cm
- Pannello impiallacciato Sp. 1,8 cm

Frontali, fianco a vista e top in:

- Pannello mdf laccato Sp. 1,8 cm con lavorazione a 45°
- Pannello rivestito lato esterno in Fenix NTM® e lato interno in tinta Sp. 1,8 cm con lavorazione a 45°
- Pannello impiallacciato Sp. 1,8 cm con lavorazione a 45°
- Pannello laccato con rivestimento in Parquet su lato esterno e interno laccato in tinta Sp. da 1,9 cm a 2,4 cm con lavorazione a 45°

Attaccaglie in acciaio regolabili con barra di rinforzo in alluminio, portata max 120 kg.

## HANGING WASHBASIN UNIT

Bottom, intermediate side panel and channel in

- 1,8 cm thick MDF lacquered panel
- 1,8 cm thick veneered panel

Front, side and top panels:

- 1,8 cm thick MDF panel with 45° chamfering
- 1,8 cm thick panel with 45° chamfering, clad in Fenix Ntm on the visible side, and laminate to match on the internal side.
- 1,8 cm thick wood veneered panel with 45° chamfering
- Lacquered panel with parquet cladding, and matching color lacquered on the inside. Thicknesses from 1,9 to 2,4 cm and 45° chamfering

St. Steel adjustable brackets with aluminum reinforcement bar. Maximum loading capacity 120 kg.

## BAS POUR LAVABO SUSPENDU

Fond, joue intermédiaire et gorge en panneau

- Panneau mdf laqué ép. 1,8 cm
- Panneau plaqué ép. 1,8 cm

Façades, côté apparent et plan en:

- Panneau mdf laqué ép. 1,8 cm avec usinage à 45°
- Panneau habillé côté externe en Fenix Ntm et côté interne stratifié dans la même couleur ép. 1,8 cm et usinage à 45°
- Panneau plaqué ép. 1,8 cm avec usinage à 45°
- Panneau laqué avec revêtement parquet à l'extérieur et à l'intérieur laqué de la même couleur ép. de 1,9 à 2,4 cm avec usinage à 45°

Accroches en acier réglables avec barre de renfort en aluminium, portée max. 120 kg.

## MUEBLE PARA LAVABO COLGANTE

Fondo, costado intermedio y gola en panel

- Panel mdf lacado esp. 1,8 cm
- Panel chapado esp. 1,8 cm

Frentes, costados vistos y encimeras en:

- Panel mdf lacado esp. 1,8 cm con junta a 45°
- Panel revestido Fenix Ntm en el lado exterior y en el lado interior laminado en color esp. 1,8 mm con junta a 45°
- Panel chapado esp. 1,8 cm con junta a 45°
- Panel lacado con revestimiento de parquet en el exterior y en el interior lacado en el mismo color esp. De 1,9 a 2,4 cm con junta a 45°

Soportes en acero ajustables con barra de refuerzo en aluminio, capacidad max. 120 kg

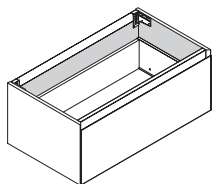

## BASE ARREDO SOSPESA

Materiali, finiture e maniglie come base reggilavabo sospesa

- Schiena in finitura laccato o impiallacciato Sp. 0,5 cm
- Schiena in finitura Fenix NTM® Sp. 1 cm

Attaccaglie in acciaio regolabili con barra di rinforzo in alluminio, portata max 120 kg.

## WALL HANGING BASE UNIT

Materials and finishes are the same as the suspended washbasin units

- 0,5 cm thick back panel available in lacquers or wood veneers finishes
- Fenix Ntm back panel 1 cm thick

St. Steel adjustable brackets with aluminum reinforcement bar. Maximum loading capacity 120 kg.

## MEUBLE BAS SUSPENDU

Matériaux et finitions comme pour bas porte-vasque suspendu

- Dos en finition laqué ou plaqué ép. 0,5 cm
- Dos en finition Fenix Ntm ép. 1 cm

Accroches en acier réglables avec barre de renfort en aluminium, portée max. 120 kg.

## MUEBLE BASE COLGANTE

Materiales y acabados como mueble para lavabo

- Trasera en acabado lacado o chapado esp. 0,5 cm
- trasera en acabado Fenix Ntm esp. 1 cm

Soportes en acero ajustables con barra de refuerzo en aluminio, capacidad max. 120 kg

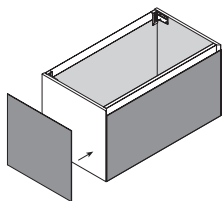

## RIVESTIMENTO DEL FIANCO

Rivestimento in Parquet applicato su lato esterno e interno in tinta con lavorazione a 45°

## SIDE PANEL'S CLADDING

Parquet covering applied on the visible side, and lacquered to match on the inside. Doors with 45° chamfering

## REVÊTEMENT DU CÔTÉ

Revêtement en parquet appliqué sur côté externe et interne laqué de la même couleur avec usinage 45°

## REVESTIMIENTO DEL COSTADO

Revestimiento en parquet en un lado exterior e interior lacado en color con junta a 45°

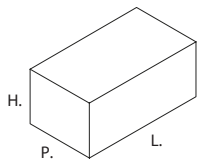

**BASE REGGILAVABO**  
WASHBASIN UNITS  
MEUBLE PAS PORTE-VASQUE  
MUEBLES LAVABOS

**H. 24**

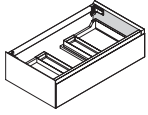

P. P. 42 - 50.5  
L. L. 60 - 75 - 90 - 105 - 120

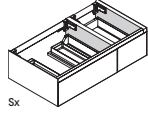

P. P. 42 - 50.5  
L. L. 90 - 105 - 120 - 135 - 120

**H. 36**

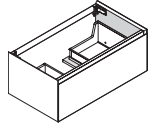

P. P. 42 - 50.5  
L. L. 60 - 75 - 90 - 105 - 120

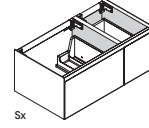

P. P. 42 - 50.5  
L. L. 90 - 105 - 120 - 135

**H. 48**

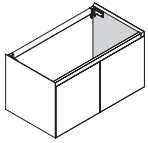

P. P. 42 - 50.5  
L. L. 60 - 90 - 120

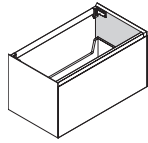

P. P. 42 - 50.5  
L. L. 60 - 75 - 90 - 105 - 120

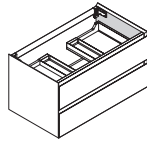

P. P. 42 - 50.5  
L. L. 60 - 75 - 90 - 105 - 120

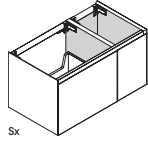

P. P. 42 - 50.5  
L. L. 90 - 105 - 120 - 135

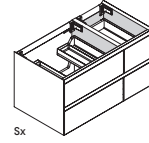

P. P. 42 - 50.5  
L. L. 90 - 105 - 120 - 135

**BASE ARREDO**  
UNIT BASE  
ÉLÉMENT BAS  
MUEBLE BAJO

**H. 24**

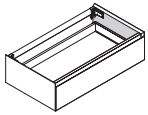

P. P. 42 - 50.5  
L. L. 30 - 45 - 60 - 75 - 90 - 105 - 120

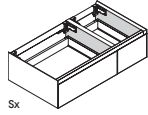

P. P. 42 - 50.5  
L. L. 90 - 105 - 120 - 135

**H. 36**

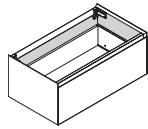

P. P. 42 - 50.5  
L. L. 30 - 45 - 60 - 75 - 90 - 105 - 120

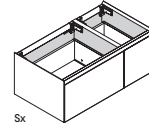

P. P. 42 - 50.5  
L. L. 90 - 105 - 120 - 135

**H. 48**

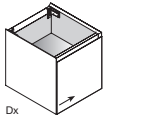

P. P. 42 - 50.5  
L. L. 30 - 45

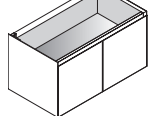

P. P. 42 - 50.5  
L. L. 60 - 90 - 120

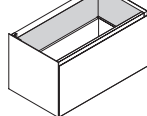

P. P. 42 - 50.5  
L. L. 30 - 45 - 60 - 75 - 90 - 105 - 120

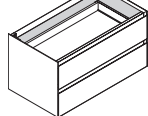

P. P. 42 - 50.5  
L. L. 30 - 45 - 60 - 75 - 90 - 105 - 120

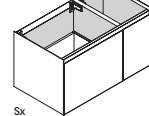

P. P. 42 - 50.5  
L. L. 90 - 105 - 120 - 135

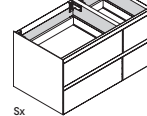

P. P. 42 - 50.5  
L. L. 90 - 105 - 120 - 135

**CARRELLI**  
TROLLEYS  
CHARIOTS  
CASTORS

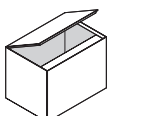

P. P. 42  
H. L. 34 - 46  
L. L. 60 - 75

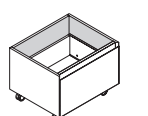

P. P. 42 - 50.5  
H. L. 43  
L. L. 60 - 75 - 90

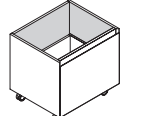

P. P. 42 - 50.5  
H. L. 55  
L. L. 60 - 75 - 90

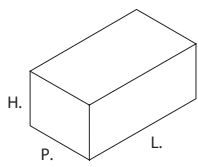

**PENSILI BORDO DRITTO**  
WALL UNITS WITH STRAIGHT EDGE  
AVEC CHANT DROIT  
MUEBLES ALTO CON CANTO RECTO

**P. 21,2**

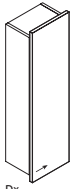

**H.** 48 - 60 - 72 - 96 - 120  
- 144 - 168  
**L.** 30

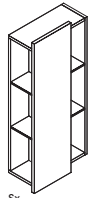

**H.** 72 - 96 - 120 - 144  
- 168  
**L.** 45

**P. 19**

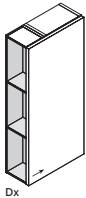

**H.** 48 - 60 - 72 - 96 - 120  
**L.** 45 - 60

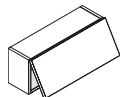

**H.** 24 - 36  
**L.** 60 - 75 - 90 - 105 -  
120

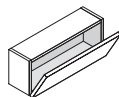

**H.** 24 - 36  
**L.** 60 - 75 - 90 - 105 -  
120



**H.** 48 - 60 - 72 - 96 - 120  
**L.** 30 - 45 - 60

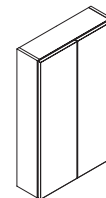

**H.** 48 - 60 - 72 - 96 - 120  
**L.** 60 - 90



**H.** 48 - 60 - 72 - 96 - 120  
**L.** 30 - 45

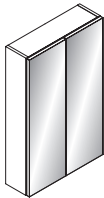

**H.** 48 - 60 - 72 - 96 - 120  
**L.** 60 - 90

**P. 36,7**

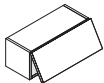

**H.** 24 - 36  
**L.** 60 - 75 - 90 - 105 -  
120

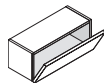

**H.** 24 - 36  
**L.** 60 - 75 - 90 - 105 -  
120



**H.** 48 - 60 - 72 - 96 - 120  
**L.** 30 - 45

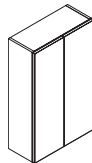

**H.** 48 - 60 - 72 - 96 - 120  
**L.** 60 - 90



**H.** 48 - 60 - 72 - 96 - 120  
**L.** 30 - 45

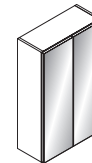

**H.** 48 - 60 - 72 - 96 - 120  
**L.** 60 - 90

**P. 69,5**

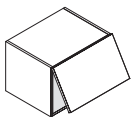

**H.** 36 - 48 - 60  
**L.** 45 - 60 - 75 - 90

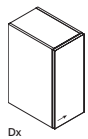

**H.** 48 - 60  
**L.** 45 - 60

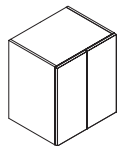

**H.** 48 - 60  
**L.** 90



# PENSILI BORDO DRITTO

Modularità  
Modularity  
Modularité  
Modularidad

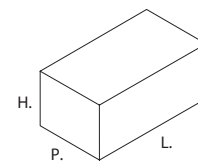

## PENSILI A GIORNO WALL UNITS OPEN ÉLÉMENTS HAUTS OUVERT MUEBLES ALTO ABIERTO

### P. 19



H. 24  
L. 30 - 45 - 60

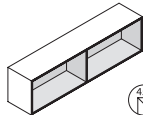

H. 24  
L. 75 - 90 - 105 - 120

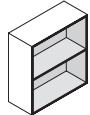

H. 36 - 48 - 60 - 72  
L. 30 - 45 - 60



H. 24 - 36 - 48 - 60 - 72  
L. 15÷30 - 30,1÷45

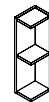

H. 36 - 48 - 60 - 72 - 96  
- 120  
L. 15 - 30

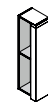

H. 36 - 48 - 60 - 72 - 96  
- 120  
L. 15

### P. 36,7

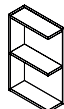

P. P. 36.7  
H. 36 - 48 - 63 - 72 - 120  
L. 15 - 30



P. P. 36.7  
H. 36 - 48 - 63 - 72 - 96 - 120  
L. 15

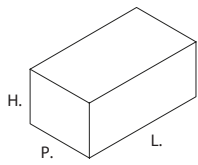

## PENSILI BORDO 45°

WALL UNITS WITH 45° EDGES  
ÉLÉMENTS HAUTS AVEC CHANT À 45°  
MUEBLES ALTO CON CANTO 45°

### P. 22

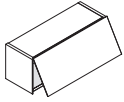

H. 24 - 36  
L. 45 - 60 - 75 - 90



H. 48 - 60 - 72 - 96 - 120  
L. 30 - 45 - 60

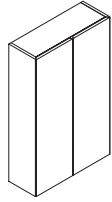

H. 48 - 60 - 72 - 96 - 120  
L. 60 - 90



H. 48 - 60 - 72 - 96 - 120  
L. 30 - 45 - 60

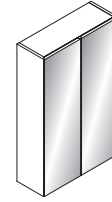

H. 48 - 60 - 72 - 96 - 120  
L. 60 - 90

## PENSILI A GIORNO CON BORDI 45°

WALL UNITS OPEN WITH 45° EDGES  
ÉLÉMENTS HAUTS OUVERTS AVEC CHANT À 45°  
MUEBLES ALTO ABIERTOS CON CANTO 45°

### P. 22

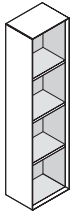

H. 24 - 36 - 48 - 60 - 72 -  
96 - 120 - 144 - 168 - 192  
L. 30 - 45 - 15

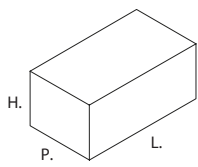

**COLONNE SOSPESSE BORDO DRITTO**  
TALL UNITS SUSPENDED WITH STRAIGHT EDGE  
COLONNES SUSPENDUES AVEC CHANT DROIT  
COLUMNAS SUSPENDIDAS CON CANTO RECTO

**P. 19**

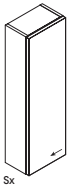

H. 144 - 168 - 192  
L. 30 - 45 - 60

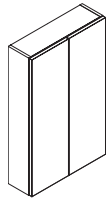

H. 144 - 168 - 192  
L. 60



H. 144 - 168 - 192  
L. 30 - 45 - 60

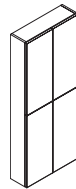

H. 144 - 168 - 192  
L. 60

**COLONNE A TERRA BORDO DRITTO CON ANTA**  
FLOOR-STANDING TALL UNITS STRAIGHT EDGE WITH DOORS  
COLONNES AU SOL CHANT DROIT AVEC PORTE  
COLUMNAS A SUELO CANTO RECTO CON PUERTA

**P. 36,7**

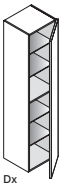

H. 144 - 168 - 192 - 218  
- 235  
L. 30 - 45 - 60

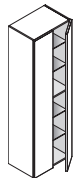

H. 144 - 168 - 192 - 218  
- 235  
L. 60

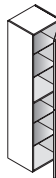

H. 144 - 168 - 192 - 235  
L. 30 - 45 - 60

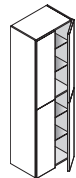

H. 144 - 168 - 192 - 235  
L. 60

**P. 45,5**

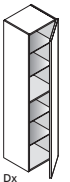

H. 144 - 168 - 192 - 218  
- 235  
L. 30 - 45 - 60

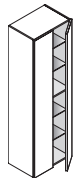

H. 144 - 168 - 192 - 218  
- 235  
L. 60

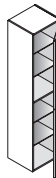

H. 144 - 168 - 192 - 235  
L. 30 - 45 - 60

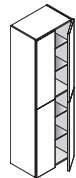

H. 144 - 168 - 192 - 235  
L. 60

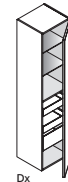

H. 144 - 168 - 192 - 218  
- 235  
L. 45 - 30 - 60

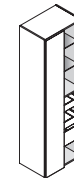

H. 144 - 168 - 192 - 218  
- 235  
L. 60

**P. 51**

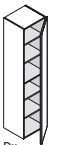

P. P. 51  
H. 192 - 235  
L. 45 - 60

**P. 69,5**

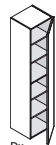

P. P. 69.5  
H. 192 - 235  
L. 45 - 60

# COLONNE BORDO DRITTO

Modularità  
Modularity  
Modularité  
Modularidad

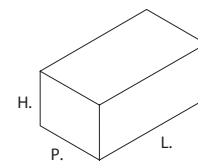

**COLONNE A TERRA BORDO DRITTO CON CASSETTI / CESTONI**  
 FLOOR-STANDING TALL UNITS STRAIGHT EDGE WITH DRAWERS AND DEEP DRAWERS  
 COLONNES AU SOL CHANT DROIT AVEC TIROIRS ET COULISSANTS  
 COLUMNAS A SUELO CANTO RECTO CON CAJONES Y GAVETAS

## P. 45,5

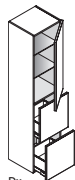

Dx  
**H.** 192 - 235  
**L.** 30 - 45 - 60

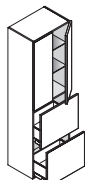

**H.** 192 - 235  
**L.** 60

## P. 51

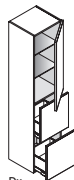

Dx  
**H.** 192 - 235  
**L.** 30 - 45 - 60

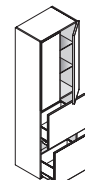

**H.** 192 - 235  
**L.** 60

## P. 69,5

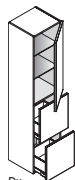

Dx  
**H.** 192 - 235  
**L.** 30 - 45 - 60

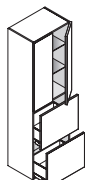

**H.** 192 - 235  
**L.** 60

**COLONNE BORDO DRITTO LAVANDERIA**  
 TALL UNITS LAUNDRY WITH STRAIGHT EDGE  
 COLONNES LESSIVE AVEC CHANT DROIT  
 COLUMNAS ROPA SUCIA CON CANTO RECTO

## P. 51



Dx  
**P. P.** 51  
**H.** 192 - 235  
**L.** 45 - 60

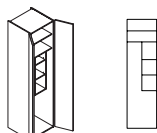

**P. P.** 51  
**H.** 192 - 235  
**L.** 60

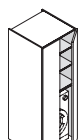

**P. P.** 51  
**H.** 192 - 235  
**L.** 75

## P. 69,5

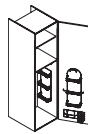

Dx  
**P. P.** 69.5  
**H.** 192 - 235  
**L.** 45 - 60

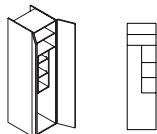

**P. P.** 69.5  
**H.** 192 - 235  
**L.** 60

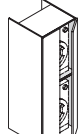

**P. P.** 69.5  
**H.** 192 - 235  
**L.** 75

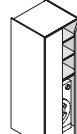

**P. P.** 69.5  
**H.** 192 - 235  
**L.** 75

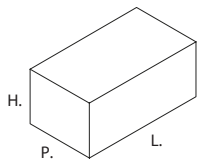

**COLONNE A GIORNO**  
TALL UNITS OPEN  
COLONNES OUVERT  
COLUMNAS ABIERTO

**P. 36,7**

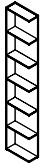

H. 144 - 168 - 192 - 218  
- 235  
L. 15 - 30

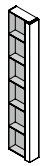

H. 144 - 168 - 192 - 218  
- 235  
L. 15

**P. 45,5**

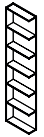

H. 144 - 168 - 192 - 218  
- 235  
L. 15 - 30

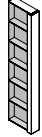

H. 144 - 168 - 192 - 218  
- 235  
L. 15

**P. 51**



H. 192 - 235  
L. 15 - 30

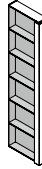

H. 192 - 235  
L. 15

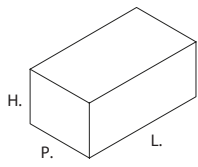

**COLONNE BORDO 45°**  
TALL UNITS WITH 45° EDGES  
COLONNES AVEC CHANT À 45°  
COLUMNAS CON CANTO 45°

**P. 22**

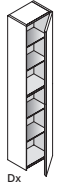

Dx

H. 144 - 168 - 192  
L. 30 - 45

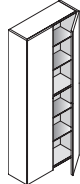

Dx

H. 144 - 168 - 192  
L. 60

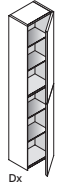

Dx

H. 144 - 168 - 192  
L. 30 - 45

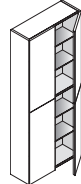

Dx

H. 144 - 168 - 192  
L. 60

**P. 42**



Dx

H. 144 - 168 - 192  
L. 30 - 45

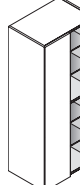

Dx

H. 144 - 168 - 192  
L. 60



Dx

H. 144 - 168 - 192  
L. 30 - 45



Dx

H. 144 - 168 - 192  
L. 60

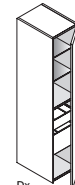

Dx

H. 144 - 168 - 192  
L. 45

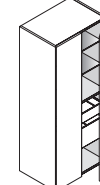

Dx

H. 144 - 168 - 192  
L. 60

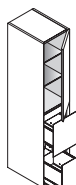

Dx

H. 144 - 168 - 192  
L. 45

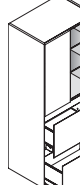

Dx

H. 144 - 168 - 192  
L. 60

# COLONNE ANGOLO

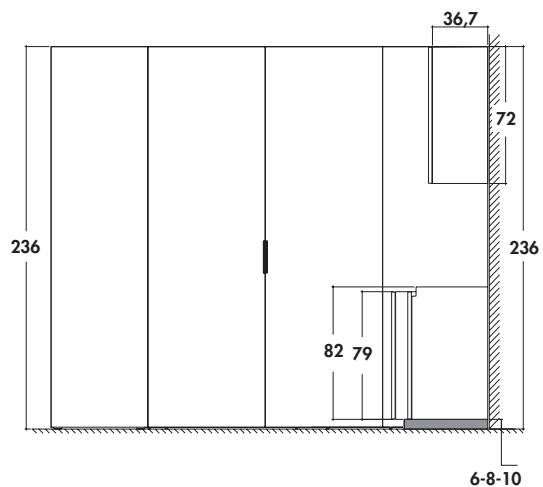

**La cabina angolo H. 236 è consigliata con i pensili H. 72**  
*The corner cabinet H. 236 is recommended with wall units H. 72*  
*Le meuble d'angle H. 236 est recommandé avec les éléments hauts H. 72*  
*Se recomienda el rinconero H. 236 con muebles altos H. 72*

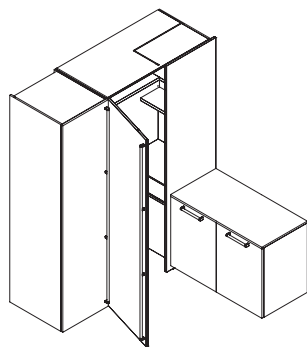

**La cabina angolo può essere accostata a basi con zoccolo H. 6 / 8 / 10**  
*Walk-in corner cabinet can be combined with base units with plinths H.6 / 8 / 10 cm*  
*La cabine d'angle peut être associée avec des éléments bas avec plinthes H.6 / 8 / 10.*  
*El mueble esquinero se puede combinar con muebles bajos con un zócalo de 6 / 8 / 10 H*

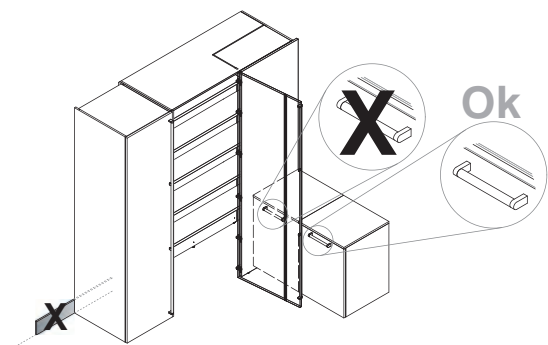

**La cabina angolo è regolabile in altezza max 2,5 cm agendo sui piedini a scomparsa**  
*The height of the walk-in corner cabinet could be adjusted by 2,5cm, acting on the concealed legs*  
*La cabine d'angle est livrée avec pieds réglables jusqu'à 2,5 cm*  
*El mueble esquinero se puede regular en altura hasta 2,5 cm actuando sobre las patas ocultas*

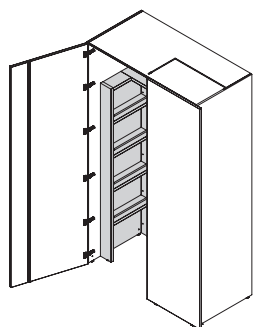

**La cabina angolo lavaggio se non accostata ad altre colonne richiede inserimento elemento Tower**  
*If the washing corner cabinet is not combined with other tall units, it requires the insertion of the Tower element*  
*Si le meuble d'angle de lavage n'est pas combiné avec d'autres meubles hauts, il nécessite l'insertion de l'élément Tower*  
*Si el mueble esquinero no se combina con otras columnas, se debe insertar el elemento Tower*