

dafne

design bolzan LAB



Caratterizzato dal cordino che percorre il profilo della testiera, sottolineandone le curve armoniose, questo letto è dedicato a chi concepisce l'ambiente notte come un nido soffice, romantico e sognante. Il nuovo piedino in legno massello dona leggerezza ed eleganza.

This bed is characterized by the cord running along the profile of the headboard, thus emphasizing its harmonious curves, and it is dedicated to those who conceive the bedroom as a soft, romantic and dreamy nest. The new solid wood foot gives lightness and elegance.

informazioni tecniche / technical info:

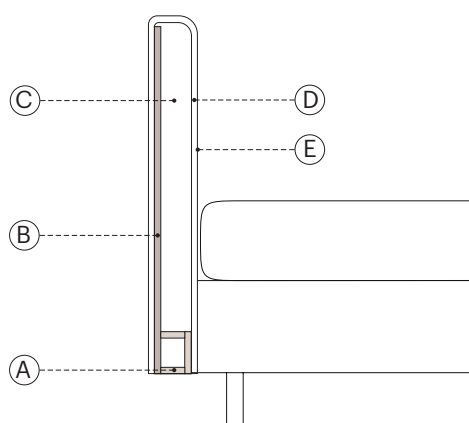

testata / headboard

- A. listellare di abete 3 strati 22mm / 22mm 3-layer fir blockboard
- B. truciolare 18 mm / 18 mm multilayer
- C. espanso ignifugo D 30 kg/mc / fire resistant foam D 30 kg/mc
- D. resinato poliestere ignifugo 100g / 100g fire retardant resin polyester fiber
- E. maglia polipropilene 70g / 70g polypropylene mesh

h 9

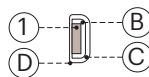

h 20

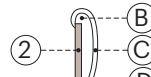

h 29

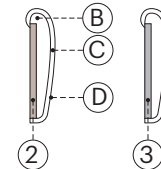

giroletti / bedframes

- 1. MDF 40mm / 40mm MDF
- B. espanso ignifugo D 35 kg/mc / fire resistant foam D 35 kg/mc
- C. resinato poliestere ignifugo 100g / 100g fire resistant resined polyester fiber
- D. maglia polipropilene 70g / 70g polypropylene mesh
- 2. listellare abete 22mm 3 strati / 22mm 3-layer fir blockboard
- 3. estruso in alluminio 22mm / 22 mm extruded aluminum

predisposto per materassi / for mattresses:

120 x 200	47 ² / ₈ "	x	78 ⁶ / ₈ "
160 x 200	63"	x	78 ⁶ / ₈ "
170 x 200	66 ⁷ / ₈ "	x	78 ⁶ / ₈ "
180 x 200	70 ⁷ / ₈ "	x	78 ⁶ / ₈ "

153 x 203	60"	x	80"	Queen size
193 x 203	76"	x	80"	King size

personalizzazioni disponibili / available customizations:

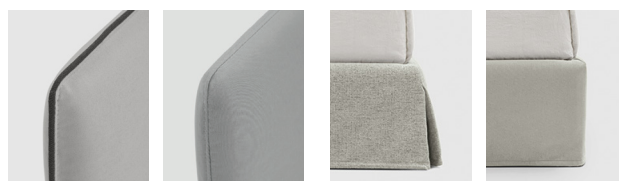

nervetto coda di topo / piping coda di topo

ribattitura chiusa

gonnellina / skirt

gonnellina / skirt chic

Dafne / Firwood structure

Standard feet Vasetto - completely removable cover in fabric - non removable headboard cover in leather – not available in eco-leather

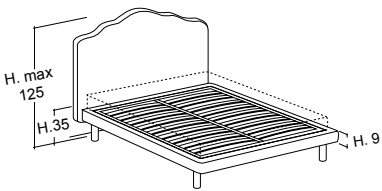
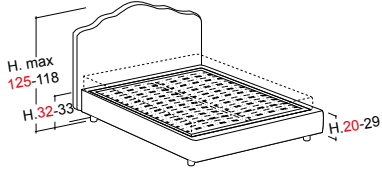
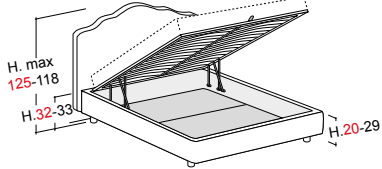
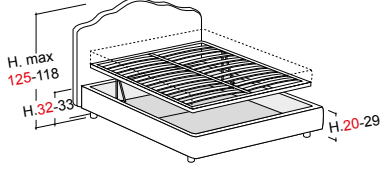
	Mattress	Ext. dimension	Code	D	C	A	Plus	Luxury fabric	Luxury leather	Nuvola fabric	Nuvola leather	TCL	Cover			
													ml	mc	kg	
thin base h.9																
orthopaedic slatted base included																
	120x200	135x221	DAD9										7.5	0.46	66	
	150x200	165x221	DAL9										7.9	0.51	76	
	153x203 QUEEN 60X80"	165x221	DAQ9										7.9	0.51	76	
	160x200	175x221	DAM9										8	0.56	79	
	170x200	185x221	DAF9										8.3	0.59	72	
	180x200	195x221	DAG9										8.5	0.62	85	
	190x200	205x221	DAP9										9	0.66	88	
	193x203 KING 76X80"	208x221	DAK9										9	0.66	88	
	Loose cover	RDA														
	rounded base h.20 - rounded base h.29															
without slatted base (to choose a slatted base see flap on the right)																
	120x200	135x221	DAD29										7.5	0.43	54	
	150x200	165x221	DAL29										7.9	0.48	62	
	153x203 QUEEN 60X80"	168x224	DAQ29										7.9	0.48	62	
	160x200	175x221	DAM29										8	0.49	63	
	170x200	185x221	DAF29										8.3	0.51	67	
	180x200	195x221	DAG29										8.5	0.53	72	
	190x200	205x221	DAP29										9	0.56	80	
	193x203 KING 76X80"	208x224	DAK29										9	0.56	80	
Loose cover	RDA												0.02	8		
rounded base h.20 - rounded base h.29 w/BOX																
orthopaedic slatted base included suggested weights for mattresses (see flap on the right)																
	120x200	135x221	DAD29B										7.5	0.62	112	
	150x200	165x221	DAL29B										7.9	0.74	127	
	153x203 QUEEN 60X80"	168x224	DAQ29B										7.9	0.74	127	
	160x200	175x221	DAM29B										8	0.75	128	
	170x200	185x221	DAF29B										8.3	0.79	135	
	180x200	195x221	DAG29B										8.5	0.82	142	
	190x200	205x221	DAP29B										9	0.85	148	
	193x203 KING 76X80"	208x224	DAK29B										9	0.85	148	
available inside height in Box 12-18cm	Loose cover	RDA											0.02	8		
rounded base h.20 - rounded base h.29 w/easy-up BOX																
orthopaedic slatted base included suggested weights for mattresses (see flap on the right)																
	120x200	135x221	DAD29BE										7.5	0.66	122	
	150x200	165x221	DAL29BE										7.9	0.79	138	
	153x203 QUEEN 60X80"	168x224	DAQ29BE										7.9	0.79	138	
	160x200	175x221	DAM29BE										8	0.79	138	
	170x200	185x221	DAF29BE										8.3	0.83	145	
	180x200	195x221	DAG29BE										8.5	0.86	152	
	190x200	205x221	DAP29BE										9	0.89	158	
	193x203 KING 76X80"	208x224	DAK29BE										9	0.89	158	
available inside height in Box 12-18cm	Loose cover	RDA											0.02	8		

Dafne / Aluminum structure

Standard feet Vasetto - completely removable cover in fabric - non removable headboard cover in leather - not available in ecoleather

	Mattress	Ext. dimension	Code	D	C	A	Plus	Luxury fabric	Luxury leather	Nuvola fabric	Nuvola leather	TCL	Cover			
													ml	mc	kg	
rounded base h.29																
without slatted base (to choose a slatted base see flap on the right)																
	120x200	135x221	DAD29A										7.5	0.43	55	
	150x200	165x221	DAL29A										7.9	0.48	65	
	153x203 QUEEN 60X80"	168x224	DAQ29A										7.9	0.48	65	
	160x200	175x221	DAM29A										8	0.49	66	
	170x200	185x221	DAF29A										8.3	0.51	73	
	180x200	195x221	DAG29A										8.5	0.53	76	
	190x200	205x221	DAP29A										9	0.56	85	
	193x203 KING 76X80"	208x224	DAK29A										9	0.56	85	
	Loose cover		RDAA											0.02	8	
rounded base h.29 w/BOX																
orthopaedic slatted base included suggested weights for mattresses (see flap on the right)																
	120x200	135x221	DAD29BA										7.5	0.62	113	
	150x200	165x221	DAL29BA										7.9	0.74	130	
	153x203 QUEEN 60X80"	168x224	DAQ29BA										7.9	0.74	130	
	160x200	175x221	DAM29BA										8	0.75	131	
	170x200	185x221	DAF29BA										8.3	0.79	141	
	180x200	195x221	DAG29BA										8.5	0.82	146	
	190x200	205x221	DAP29BA										9	0.85	153	
	193x203 KING 76X80"	208x224	DAK29BA										9	0.85	153	
	Loose cover		RDAA											0.02	8	
rounded base h.29 w/easy-up BOX																
orthopaedic slatted base included suggested weights for mattresses (see flap on the right)																
	120x200	135x221	DAD29BEA										7.5	0.66	123	
	150x200	165x221	DAL29BEA										7.9	0.79	141	
	153x203 QUEEN 60X80"	168x224	DAQ29BEA										7.9	0.79	141	
	160x200	175x221	DAM29BEA										8	0.79	141	
	170x200	185x221	DAF29BEA										8.3	0.83	151	
	180x200	195x221	DAG29BEA										8.5	0.86	156	
	190x200	205x221	DAP29BEA										9	0.89	163	
	193x203 KING 76X80"	208x224	DAK29BEA										9	0.89	163	
	Loose cover		RDAA											0.02	8	
rounded base h.29 w/HANDS FREE BOX																
orthopaedic slatted base included Specify mattress weight (see flap on the right)																
	150x200	165x222	DAL29BHF										7.9	0.78	136	
	153x203 QUEEN 60X80"	168x227	DAQ29BHF										7.9	0.78	136	
	160x200	175x222	DAM29BHF										8	0.79	137	
	170x200	185x222	DAF29BHF										8.3	0.83	147	
	180x200	195x222	DAG29BHF										8.5	0.86	153	
	190x200	205x222	DAP29BHF										9	0.89	161	
	193x203 KING 76X80"	208x227	DAK29BHF										9	0.89	161	
	Loose cover		RDAHf											0.02	8	

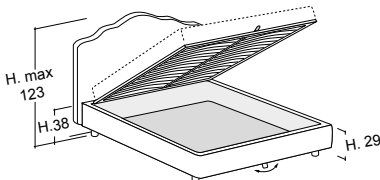
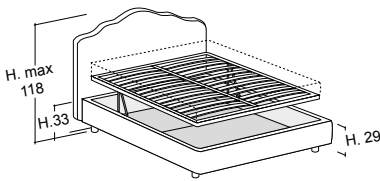
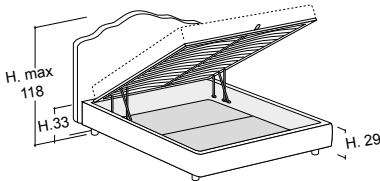
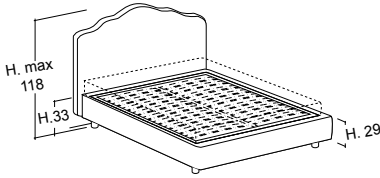

GIROLETTI E PIEDINI / BEDFRAMES AND FEET

bedframe h.9 cm



cilindro
H 26 cm 10²/₈"



vasetto
H 26 cm 10²/₈"



vasetto inclinato
H 26 cm 10²/₈"



tubino
H 26 cm 10²/₈"



lamina
H 26 cm 10²/₈"



arco
H 26 cm 10²/₈"

bedframe h.20 cm



cilindro
H 12,5 cm 4⁷/₈"



vasetto
H 12,5 cm 4⁷/₈"



tubino
H 12,5 cm 4⁷/₈"



lamina
H 15 cm 5⁷/₈"

bedframe h.29 cm



vasetto h. 4cm
H 4 cm 1⁵/₈"



vasetto h. 9-12,5 cm
H 9 cm 3⁴/₈"
H 12,5 cm 4⁷/₈"



cipolla
H 8 cm 3¹/₈"

pedini in legno / wooden feet:

pedini realizzati in legno di pino con possibilità di essere tinti, verniciati ral o foderati in tessuto a scelta.

pedini realizzati in legno di pino con possibilità di essere tinti, verniciati ral o foderati in tessuto a scelta.

finiture legno tinto / lacquered wood finishes:



noce / walnut



ciliegio / cherry



rovere / oak



wengè

pedini in metallo / metal feet:

pedini realizzati in acciaio con possibilità di essere verniciati effetto ottone o colori ral.

pedini realizzati in acciaio con possibilità di essere verniciati effetto ottone o colori ral.

finiture metallo / metal finishes:



ottone satinato /
brushed brass

finiture laccati ral / ral lacquered finishes:



bianco / white
RAL 9010



perla / pearl
RAL 1013



nero / black
RAL 9011



grigio / grey
RAL 7044



marrone / brown
RAL 8019



rosso / red
RAL 3005



verde / green
RAL 6020



blu / blue
RAL 5008

h. 20-29 SISTEMA CONTENITORE / BOX SYSTEM



box

BOX

apertura basic del box grazie ad un semplice sistema a leva / basic opening of storage box thanks to a simple lever system

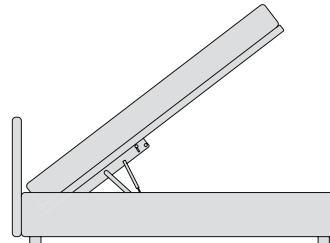

interno in legno



interno in alluminio

HANDS-FREE

apertura del box senza l'uso delle mani e grazie al box completamente in alluminio è privo di pistoncini a vista / The mechanism allows to open the storage box without hands, and thanks to its aluminum structure, the storage box has inner pistons, thus maintaining a top-notch design

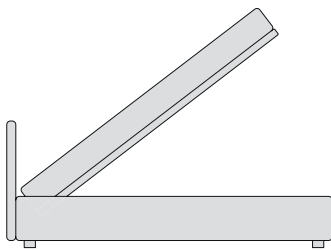

interno in alluminio

EASY UP

grazie al movimento che mantiene la rete all'interno dello spazio occupato dal letto, ottimizza lo spazio all'interno della stanza / mechanism optimizes the space inside the room thanks to its movement that keeps the slatted base within the space occupied by the bed

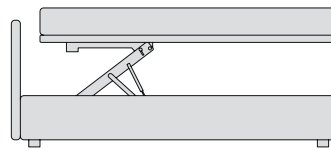

interno in legno



interno in alluminio

h. 20-29 INCASSO MATERASSO / MATTRESS RECESS

La struttura dei letti Bolzan permette di soddisfare le diverse esigenze di progettazione: l'incasso del materasso nella struttura del letto è personalizzabile in 7 altezze diverse. Non disponibile per le basi con box.

Bolzan beds' structure allows you to meet different design needs: the mattress recess in the bed's structure is customizable in 7 different heights. It is not available for bases with box.

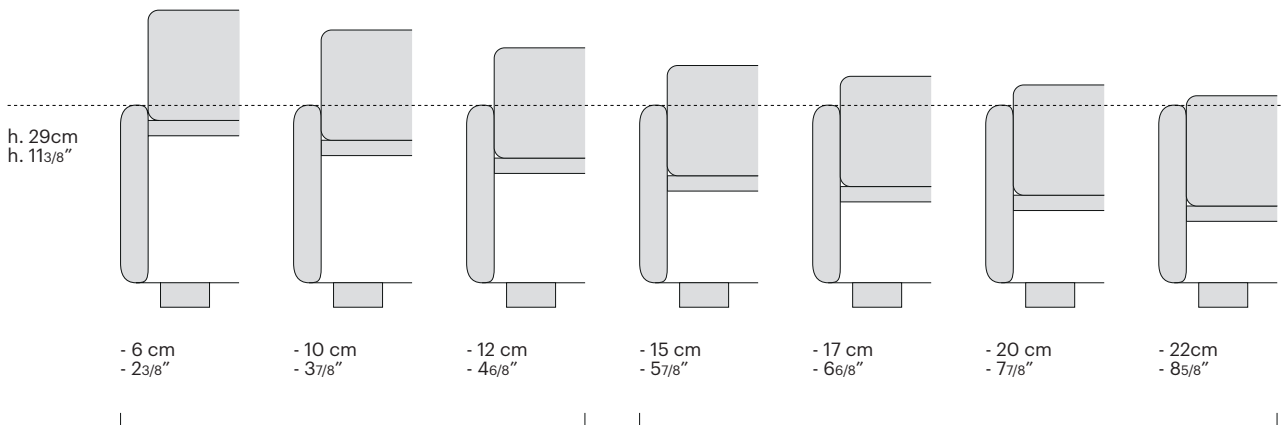

ribassamento disponibile per giroletto h. 20 e h. 29 cm /
mattress recess available for h. 20 and h. 29 cm bedframes

ribassamento disponibile solo per giroletto h. 29 cm /
mattress recess available for h. 29 cm bedframe