

freedom

design bolzan LAB



Un classico reinventato nel segno della sapienza stilistica e della cura sartoriale nei dettagli. Freedom veste l'essenzialità contemporanea delle sue linee, con il prestigio e il comfort della testiera capitonné. Le cuciture a vista del rivestimento, esprimono un valore artigianale e contribuiscono a creare un'estetica affascinante.

A re-invented classic in the sign of stylistic wisdom and tailoring care for details. Freedom symbolizes the contemporary simplicity of its lines, with the prestige and the comfort of its capitonné headboard. The seams at sight of its cover express a handicraft value and contribute creating a captivating appearance.

informazioni tecniche / technical info:

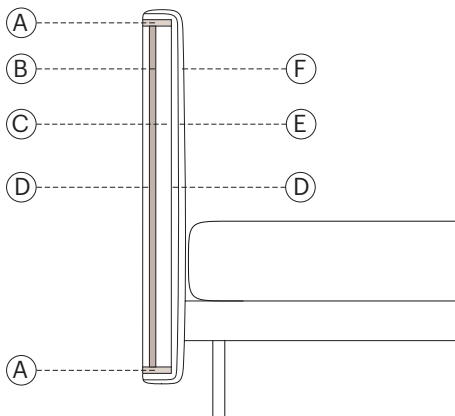

testata / headboard

- A. listellare abete 22mm 3 strati / 22mm 3-layer fir blockboard
- B. multistrato pioppo 18mm / 18mm poplar multilayer
- C. espanso ignifugo D 20 kg/mc / fire retardant foam D 20 kg/mc
- D. espanso ignifugo D 25 kg/mc / fire retardant foam D 25 kg/mc
- E. ovatta poliestere ignifuga 300g / 300g fire resistant resin polyester fibre
- F. maglina polipropilene 70g / 70g polypropylene mesh

h 9

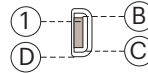

h 29

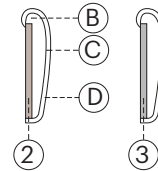

giroletti / bedframes

- 1. MDF 40mm / 40mm MDF
- B. espanso ignifugo D 35 kg/mc / fire resistant foam D 35 kg/mc
- C. resinato poliestere ignifugo 100g / 100g fire resistant resined polyester fiber
- D. maglia polipropilene 70g / 70g polypropylene mesh
- 2. listellare abete 22mm 3 strati / 22mm 3-layer fir blockboard
- 3. estruso in alluminio 22mm / 22 mm extruded aluminum

predisposto per materassi / for mattresses:

90 x 200	35 ³ / ₈ " x 78 ⁶ / ₈ "
120 x 200	47 ² / ₈ " x 78 ⁶ / ₈ "
140 x 200	55 ¹ / ₈ " x 78 ⁶ / ₈ "
160 x 200	63" x 78 ⁶ / ₈ "
170 x 200	66 ⁷ / ₈ " x 78 ⁶ / ₈ "
180 x 200	70 ⁷ / ₈ " x 78 ⁶ / ₈ "

137 x 190	54" x 75"	F ull double size
153 x 203	60" x 80"	Q ueen size
193 x 203	76" x 80"	K ing size

Freedom / Firwood structure

Standard feet Vasetto - non removable headboard cover - available with or without buttons

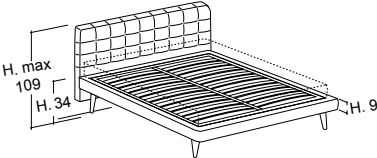
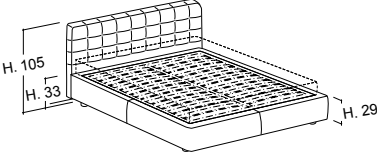
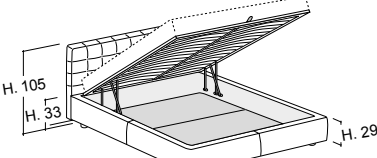
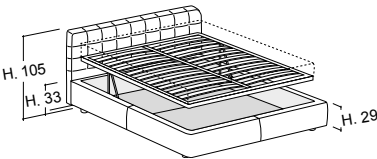
	Mattress	Ext. dimension	Code	D	C	A	Plus	Luxury fabric	Luxury leather	Nuvola fabric	Nuvola leather	TCL	Cover		
													ml	mc	kg
thin base h.9 orthopaedic slatted base included carrying slat 	120x200	141x218	FRD9										7	0.36	61
	135x190	161x208	FRI9										7.4	0.38	67
	137x190 DOUBLE 54X75	161x208	FRE9										7.4	0.38	67
	140x200	161x218	FRU9										7.5	0.38	67
	150x200	181x218	FRL9										7.8	0.41	74
	153x203 QUEEN 60X80	181x218	FRQ9										7.8	0.41	74
	160x200	181x218	FRM9										8	0.41	74
	180x200	201x218	FRG9										8.5	0.43	80
	190x200	221x218	FRP9										9	0.45	86
	193x203 KING 76X80	221x218	FRK9										9	0.45	86
	Loose cover			R9										0.02	
rounded base h.29 without slatted base (to choose a slatted base see flap on the right) 	120x200	141x221	FRD29										7	0.45	63
	135x190	161x211	FRI29										7.4	0.47	68
	137x190 DOUBLE 54X75	161x211	FRE29										7.4	0.47	68
	140x200	161x221	FRU29										7.5	0.47	68
	150x200	181x221	FRL29										7.8	0.5	74
	153x203 QUEEN 60X80	181x224	FRQ29										7.8	0.5	74
	160x200	181x221	FRM29										8	0.5	74
	180x200	201x221	FRG29										8.5	0.52	80
	190x200	221x221	FRP29										9	0.54	86
	193x203 KING 76X80	221x224	FRK29										9	0.54	86
	Loose cover			R29										0.02	
rounded base h.29 w/BOX orthopaedic slatted base included suggested weights for mattresses (see flap on the right) 	120x200	141x221	FRD29B										7	0.63	121
	135x190	161x211	FRI29B										7.4	0.69	129
	137x190 DOUBLE 54X75	161x211	FRE29B										7.4	0.69	129
	140x200	161x221	FRU29B										7.5	0.69	129
	150x200	181x221	FRL29B										7.8	0.75	139
	153x203 QUEEN 60X80	181x224	FRQ29B										7.8	0.75	139
	160x200	181x221	FRM29B										8	0.75	139
	180x200	201x221	FRG29B										8.5	0.79	150
	190x200	221x221	FRP29B										9	0.83	161
	193x203 KING 76X80	221x224	FRK29B										9	0.83	161
	available inside height in Box 18cm			R29B										0.02	
rounded base h.29 w/easy-up BOX orthopaedic slatted base included suggested weights for mattresses (see flap on the right) 	120x200	141x221	FRD29BE										7	0.67	131
	135x190	161x211	FRI29BE										7.4	0.73	139
	137x190 DOUBLE 54X75	161x211	FRE29BE										7.4	0.73	139
	140x200	161x221	FRU29BE										7.5	0.73	139
	150x200	181x221	FRL29BE										7.8	0.79	149
	153x203 QUEEN 60X80	181x224	FRQ29BE										7.8	0.79	149
	160x200	181x221	FRM29BE										8	0.79	149
	180x200	201x221	FRG29BE										8.5	0.83	160
	190x200	221x221	FRP29BE										9	0.87	171
	193x203 KING 76X80	221x224	FRK29BE										9	0.87	171
	available inside height in Box 18cm			R29BE										0.02	

Freedom / Aluminum structure

Standard feet Vasetto - non removable headboard cover - available with or without buttons

	Mattress	Ext. dimension	Code	D	C	A	Plus	Luxury fabric	Luxury leather	Nuvola fabric	Nuvola leather	TCL	Cover			
													ml	mc	kg	
rounded base h.29 without slatted base (to choose a slatted base see flap on the right)	120x200	141x221	FRD29A										7	0.45	64	
	135x190	161x211	FRI29A										7.4	0.47	70	
	137x190 DOUBLE 54X75"	161x211	FRE29A										7.4	0.47	70	
	140x200	161x221	FRU29A										7.5	0.47	70	
	150x200	181x221	FRL29A										7.8	0.5	77	
	153x203 QUEEN 60X80"	181x224	FRQ29A										7.8	0.5	77	
	160x200	181x221	FRM29A										8	0.5	77	
	180x200	201x221	FRG29A										8.5	0.52	84	
	190x200	221x221	FRP29A										9	0.54	91	
	193x203 KING 76X80"	221x224	FRK29A										9	0.54	91	
		Loose cover		R29A											0.02	5
rounded base h.29 w/BOX orthopaedic slatted base included suggested weights for mattresses (see flap on the right)	120x200	141x221	FRD29BA										7	0.63	122	
	135x190	161x211	FRI29BA										7.4	0.69	131	
	137x190 DOUBLE 54X75"	161x211	FRE29BA										7.4	0.69	131	
	140x200	161x221	FRU29BA										7.5	0.69	131	
	150x200	181x221	FRL29BA										7.8	0.75	142	
	153x203 QUEEN 60X80"	181x224	FRQ29BA										7.8	0.75	142	
	160x200	181x221	FRM29BA										8	0.75	142	
	180x200	201x221	FRG29BA										8.5	0.79	154	
	190x200	221x221	FRP29BA										9	0.83	166	
	193x203 KING 76X80"	221x224	FRK29BA										9	0.83	166	
		Loose cover		R29BA											0.02	5
rounded base h.29 w/easy-up BOX orthopaedic slatted base included suggested weights for mattresses (see flap on the right)	120x200	141x221	FRD29BEA										7	0.67	132	
	135x190	161x211	FRI29BEA										7.4	0.73	141	
	137x190 DOUBLE 54X75"	161x211	FRE29BEA										7.4	0.73	141	
	140x200	161x221	FRU29BEA										7.5	0.73	141	
	150x200	181x221	FRL29BEA										7.8	0.79	152	
	153x203 QUEEN 60X80"	181x224	FRQ29BEA										7.8	0.79	152	
	160x200	181x221	FRM29BEA										8	0.79	152	
	180x200	201x221	FRG29BEA										8.5	0.83	164	
	190x200	221x221	FRP29BEA										9	0.87	176	
	193x203 KING 76X80"	221x224	FRK29BEA										9	0.87	176	
		Loose cover		R29BEA											0.02	5
rounded base h.29 w/HANDS FREE BOX orthopaedic slatted base included Specify mattress weight (see flap on the right)	150x200	181x224	FRL29BHF										7.8	0.79	148	
	160x200	181x224	FRM29BHF										8	0.79	148	
	180x200	201x224	FRG29BHF										8.5	0.83	161	
	190x200	221x224	FRP29BHF										9	0.87	174	
	193x203 KING 76X80"	221x227	FRK29BHF										9	0.87	174	
		Loose cover		R29BHF											0.02	

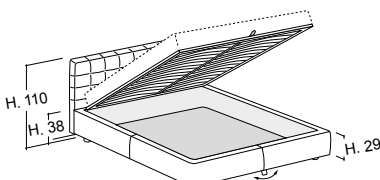
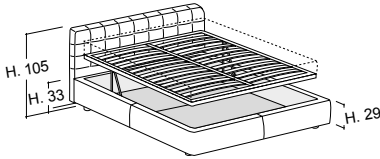
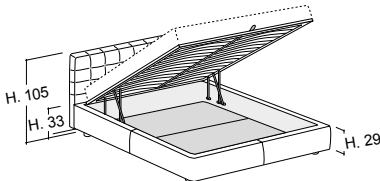
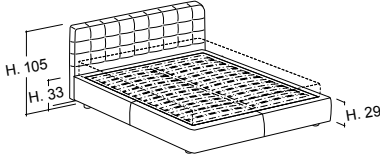

Freedom Medium / Firwood structure

Standard feet Vasetto - non removable headboard cover - available with or without buttons

	Mattress	Ext. dimension	Code	D	C	A	Plus	Luxury fabric	Luxury leather	Nuvola fabric	Nuvola leather	TCL	Cover			
													ml	mc	kg	
rounded base h.29																
without slatted base (to choose a slatted base see flap on the right)																
	120x200	141x221	FRMD29										7.5	0.49	66	
	135x190	161x211	FRMI29										7.9	0.52	72	
	137x190 DOUBLE 54X75"	161x211	FRME29										7.9	0.52	72	
	140x200	161x221	FRMU29										8	0.52	72	
	150x200	181x221	FRML29										8.3	0.55	78	
	153x203 QUEEN 60X80"	181x224	FRMQ29										8.3	0.55	78	
	160x200	181x221	FRMM29										8.5	0.55	78	
	180x200	201x221	FRMG29										9	0.58	85	
	190x200	221x221	FRMP29										9.5	0.61	92	
	193x203 KING 76X80"	221x224	FRMK29										9.5	0.61	92	
	Loose cover		R29											0.02	5	
rounded base h.29 w/BOX																
orthopaedic slatted base included suggested weights for mattresses (see flap on the right)																
	120x200	141x221	FRMD29B										7.5	0.67	124	
	135x190	161x211	FRMI29B										7.9	0.74	133	
	137x190 DOUBLE 54X75"	161x211	FRME29B										7.9	0.74	133	
	140x200	161x221	FRMU29B										8	0.74	133	
	150x200	181x221	FRML29B										8.3	0.8	143	
	153x203 QUEEN 60X80"	181x224	FRMQ29B										8.3	0.8	143	
	160x200	181x221	FRMM29B										8.5	0.8	143	
	180x200	201x221	FRMG29B										9	0.85	155	
	190x200	221x221	FRMP29B										9.5	0.9	167	
	193x203 KING 76X80"	221x224	FRMK29B										9.5	0.9	167	
	Loose cover		R29B											0.02	5	
rounded base h.29 w/easy-up BOX																
orthopaedic slatted base included suggested weights for mattresses (see flap on the right)																
	120x200	141x221	FRMD29BE										7.5	0.71	134	
	135x190	161x211	FRMI29BE										7.9	0.78	143	
	137x190 DOUBLE 54X75"	161x211	FRME29BE										7.9	0.78	143	
	140x200	161x221	FRMU29BE										8	0.78	143	
	150x200	181x221	FRML29BE										8.3	0.84	153	
	153x203 QUEEN 60X80"	181x224	FRMQ29BE										8.3	0.84	153	
	160x200	181x221	FRMM29BE										8.5	0.84	153	
	180x200	201x221	FRMG29BE										9	0.89	165	
	190x200	221x221	FRMP29BE										9.5	0.94	177	
	193x203 KING 76X80"	221x224	FRMK29BE										9.5	0.94	177	
	Loose cover		R29BE											0.02	5	

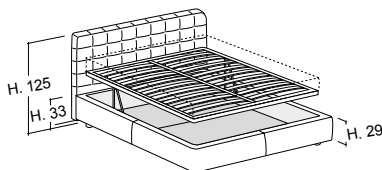
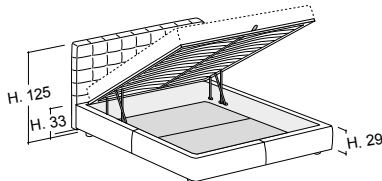
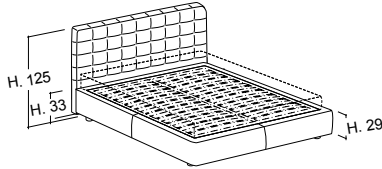

available inside height in Box 18cm

Freedom Medium / Aluminum structure

Standard feet Vasetto - non removable headboard cover - available with or without buttons

	Mattress	Ext. dimension	Code	D	C	A	Plus	Luxury fabric	Luxury leather	Nuvola fabric	Nuvola leather	TCL	Cover		
													ml	mc	kg
rounded base h.29 without slatted base (to choose a slatted base see flap on the right)	120x200	141x221	FRMD29A										7.5	0.49	67
	135x190	161x211	FRMI29A										7.9	0.52	74
	137x190 DOUBLE 54X75	161x211	FRME29A										7.9	0.52	74
	140x200	161x221	FRMU29A										8	0.52	74
	150x200	181x221	FRML29A										8.3	0.55	81
	153x203 QUEEN 60X80	181x224	FRMQ29A										8.3	0.55	81
	160x200	181x221	FRMM29A										8.5	0.55	81
	180x200	201x221	FRMG29A										9	0.58	89
	190x200	221x221	FRMP29A										9.5	0.61	97
	193x203 KING 76X80	221x224	FRMK29A										9.5	0.61	97
	Loose cover		R29A											0.02	5
rounded base h.29 w/BOX orthopaedic slatted base included suggested weights for mattresses (see flap on the right)	120x200	141x221	FRMD29BA										7.5	0.67	125
	135x190	161x211	FRMI29BA										7.9	0.74	135
	137x190 DOUBLE 54X75	161x211	FRME29BA										7.9	0.74	135
	140x200	161x221	FRMU29BA										8	0.74	135
	150x200	181x221	FRML29BA										8.3	0.8	146
	153x203 QUEEN 60X80	181x224	FRMQ29BA										8.3	0.8	146
	160x200	181x221	FRMM29BA										8.5	0.8	146
	180x200	201x221	FRMG29BA										9	0.85	159
	190x200	221x221	FRMP29BA										9.5	0.9	172
	193x203 KING 76X80	221x224	FRMK29BA										9.5	0.9	172
available inside height in Box 18cm	Loose cover		R29BA											0.02	5
rounded base h.29 w/easy-up BOX orthopaedic slatted base included suggested weights for mattresses (see flap on the right)	120x200	141x221	FRMD29BEA										7.5	0.71	135
	135x190	161x211	FRMI29BEA										7.9	0.78	145
	137x190 DOUBLE 54X75	161x211	FRME29BEA										7.9	0.78	145
	140x200	161x221	FRMU29BEA										8	0.78	145
	150x200	181x221	FRML29BEA										8.3	0.84	156
	153x203 QUEEN 60X80	181x224	FRMQ29BEA										8.3	0.84	156
	160x200	181x221	FRMM29BEA										8.5	0.84	156
	180x200	201x221	FRMG29BEA										9	0.89	169
	190x200	221x221	FRMP29BEA										9.5	0.94	182
	193x203 KING 76X80	221x224	FRMK29BEA										9.5	0.94	182
available inside height in Box 18cm	Loose cover		R29BEA											0.02	5
rounded base h.29 w/HANDS FREE BOX orthopaedic slatted base included Specify mattress weight (see flap on the right)	150x200	181x224	FRML29BHF										8.3	0.84	154
	153x203 QUEEN 60X80	181x227	FRMQ29BHF										8.3	0.84	154
	160x200	181x224	FRMM29BHF										8.5	0.84	154
	180x200	201x224	FRMG29BHF										9	0.89	166
	190x200	221x224	FRMP29BHF										9.5	0.94	180
	193x203 KING 76X80	221x227	FRMK29BHF										9.5	0.94	180
	available inside height in Box 18cm	Loose cover		R29BHF											0.02

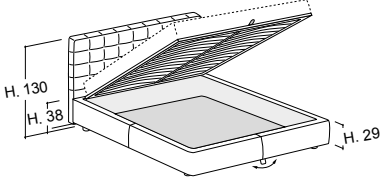
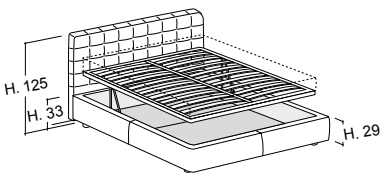
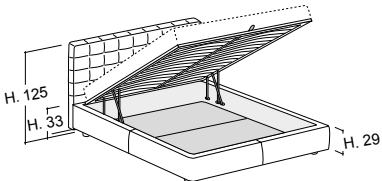
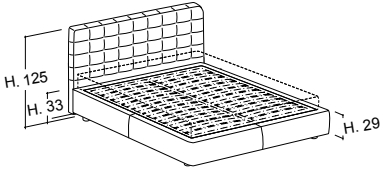

Freedom Big / Firwood structure

Standard feet Vasetto - non removable headboard cover - available with or without buttons

	Mattress	Ext. dimension	Code	D	C	A	Plus	Luxury fabric	Luxury leather	Nuvola fabric	Nuvola leather	TCL	Cover		
													ml	mc	kg
rounded base h.29 without slatted base (to choose a slatted base see flap on the right)	120x200	141x221	FRBD29										8	0.52	71
	135x190	161x211	FRBI29										8.4	0.56	77
	137x190 DOUBLE 54X75"	161x211	FRBE29										8.4	0.56	77
	140x200	161x221	FRBU29										8.5	0.56	77
	150x200	181x221	FRBL29										8.8	0.6	82
	153x203 QUEEN 60X80"	181x224	FRBQ29										8.8	0.6	82
	160x200	181x221	FRBM29										9	0.6	82
	180x200	201x221	FRBG29										9.5	0.64	87
	190x200	221x221	FRBP29										10	0.68	92
	193x203 KING 76X80"	221x224	FRBK29										10	0.68	92
	Loose cover		R29											0.02	5
rounded base h.29 w/BOX orthopaedic slatted base included suggested weights for mattresses (see flap on the right)	120x200	141x221	FRBD29B										8	0.71	129
	135x190	161x211	FRBI29B										8.4	0.78	138
	137x190 DOUBLE 54X75"	161x211	FRBE29B										8.4	0.78	138
	140x200	161x221	FRBU29B										8.5	0.78	138
	150x200	181x221	FRBL29B										8.8	0.85	147
	153x203 QUEEN 60X80"	181x224	FRBQ29B										8.8	0.85	147
	160x200	181x221	FRBM29B										9	0.85	147
	180x200	201x221	FRBG29B										9.5	0.9	159
	190x200	221x221	FRBP29B										10	0.95	171
	193x203 KING 76X80"	221x224	FRBK29B										10	0.95	171
available inside height in Box 18cm	Loose cover		R29B											0.02	5
rounded base h.29 w/easy-up BOX orthopaedic slatted base included suggested weights for mattresses (see flap on the right)	120x200	141x221	FRBD29BE										8	0.75	139
	135x190	161x211	FRBI29BE										8.4	0.82	148
	137x190 DOUBLE 54X75"	161x213	FRBE29BE										8.4	0.82	148
	140x200	161x221	FRBU29BE										8.5	0.82	148
	150x200	181x221	FRBL29BE										8.8	0.89	157
	153x203 QUEEN 60X80"	181x226	FRBQ29BE										8.8	0.89	157
	160x200	181x221	FRBM29BE										9	0.89	157
	180x200	201x221	FRBG29BE										9.5	0.94	169
	190x200	221x221	FRBP29BE										10	0.99	181
	193x203 KING 76X80"	221x226	FRBK29BE										10	0.99	181
available inside height in Box 18cm	Loose cover		R29BE											0.02	5

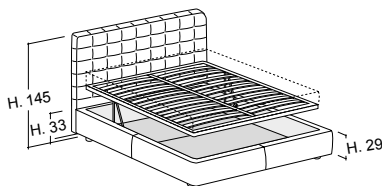
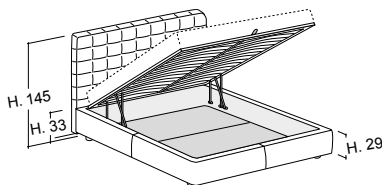
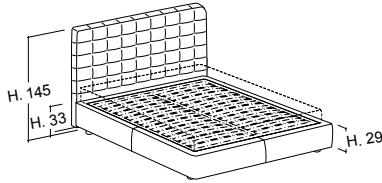

Freedom Big / Aluminum structure

Standard feet Vasetto - non removable headboard cover - available with or without buttons

	Mattress	Ext. dimension	Code	D	C	A	Plus	Luxury fabric	Luxury leather	Nuvola fabric	Nuvola leather	TCL	Cover			
													ml	mc	kg	
rounded base h.29 without slatted base (to choose a slatted base see flap on the right)	120x200	141x221	FRBD29A										8	0.52	72	
	135x190	161x211	FRBI29A										8.4	0.56	79	
	137x190 DOUBLE 54X75"	161x211	FRBE29A										8.4	0.56	79	
	140x200	161x221	FRBU29A										8.5	0.56	79	
	150x200	181x221	FRBL29A										8.8	0.6	85	
	153x203 QUEEN 60X80"	181x224	FRBQ29A										8.8	0.6	85	
	160x200	181x221	FRBM29A										9	0.6	85	
	180x200	201x221	FRBG29A										9.5	0.64	91	
	190x200	221x221	FRBP29A										10	0.68	97	
	193x203 KING 76X80"	221x224	FRBK29A										10	0.68	97	
	Loose cover		R29A											0.02	5	
rounded base h.29 w/BOX orthopaedic slatted base included suggested weights for mattresses (see flap on the right)	120x200	141x221	FRBD29BA										8	0.71	130	
	135x190	161x211	FRBI29BA										8.4	0.78	140	
	137x190 DOUBLE 54X75"	161x211	FRBE29BA										8.4	0.78	140	
	140x200	161x221	FRBU29BA										8.5	0.78	140	
	150x200	181x221	FRBL29BA										8.8	0.85	150	
	153x203 QUEEN 60X80"	181x224	FRBQ29BA										8.8	0.85	150	
	160x200	181x221	FRBM29BA										9	0.85	150	
	180x200	201x221	FRBG29BA										9.5	0.9	163	
	190x200	221x221	FRBP29BA										10	0.95	176	
	193x203 KING 76X80"	221x224	FRBK29BA										10	0.95	176	
	Loose cover		R29BA											0.02	5	
rounded base h.29 w/easy-up BOX orthopaedic slatted base included suggested weights for mattresses (see flap on the right)	120x200	141x221	FRBD29BEA										8	0.75	140	
	135x190	161x211	FRBI29BEA										8.4	0.82	150	
	137x190 DOUBLE 54X75"	161x211	FRBE29BEA										8.4	0.82	150	
	140x200	161x221	FRBU29BEA										8.5	0.82	150	
	150x200	181x221	FRBL29BEA										8.8	0.89	160	
	153x203 QUEEN 60X80"	181x224	FRBQ29BEA										8.8	0.89	160	
	160x200	181x221	FRBM29BEA										9	0.89	160	
	180x200	201x221	FRBG29BEA										9.5	0.94	173	
	190x200	221x221	FRBP29BEA										10	0.99	186	
	193x203 KING 76X80"	221x224	FRBK29BEA										10	0.99	186	
	Loose cover		R29BEA											0.02	5	
rounded base h.29 w/HANDS FREE BOX orthopaedic slatted base included Specify mattress weight (see flap on the right)	150x200	181x224	FRBL29BHF										8.8	0.89	156	
	153x203 QUEEN 60X80"	181x227	FRBQ29BHF										8.8	0.89	156	
	160x200	181x224	FRBM29BHF										9	0.89	156	
	180x200	201x224	FRBG29BHF										9.5	0.94	170	
	190x200	221x224	FRBP29BHF										10	0.99	184	
	193x203 KING 76X80"	221x227	FRBK29BHF										10	0.99	184	
		Loose cover		R29BHF											0.02	

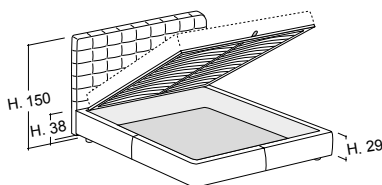
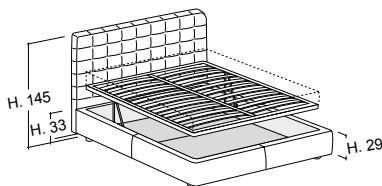
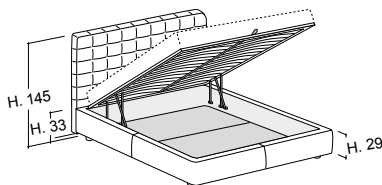
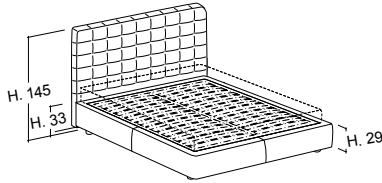

GIROLETTI E PIEDINI / BEDFRAMES AND FEET

pieдини in legno / wooden feet:

pieдини realizzati in legno di frassino con possibilità di essere tinti, verniciati ral o foderati in tessuto a scelta.

ash wood legs with the possibility of being dyed, RAL varnished or lined with fabric (of your choice)

pieдини in metallo / metal feet:

pieдини realizzati in metallo con possibilità di essere verniciati effetto ottone o colori ral.

metal legs with the possibility of being painted in brass effect or RAL varnished.

bedframe h.9 cm



cilindro

H 26 cm 10²/₈"



vasetto

H 26 cm 10²/₈"



vasetto inclinato

H 26 cm 10²/₈"

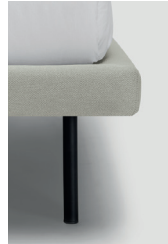

tubino

H 26 cm 10²/₈"



lamina

H 26 cm 10²/₈"



arco

H 26 cm 10²/₈"

bedframe h.20 cm



cilindro

H 12,5 cm 4⁷/₈"



vasetto

H 12,5 cm 4⁷/₈"



tubino

H 12,5 cm 4⁷/₈"



lamina

H 15 cm 5⁷/₈"

bedframe h.29 cm



vasetto h. 4cm

H 4 cm 1⁵/₈"



vasetto h. 9-12,5 cm

H 9 cm 3⁴/₈"

H 12,5 cm 4⁷/₈"



cipolla

H 8 cm 3¹/₈"

finiture legno tinto / lacquered wood finishes:



noce / walnut



ciliegio / cherry



rovere / oak



wengè

finiture metallo / metal finishes:



ottone satinato / brushed brass

finiture laccati ral / ral lacquered finishes:



bianco / white
RAL 9010



nero / black
RAL 9011



grigio / grey
RAL 7044



marrone / brown
RAL 8019



rosso / red
RAL 3005



verde / green
RAL 6020



blu / blue
RAL 5008

h. 20-29 SISTEMA CONTENITORE / BOX SYSTEM



box

BOX

apertura basic del box grazie ad un semplice sistema a leva / basic opening of storage box thanks to a simple lever system

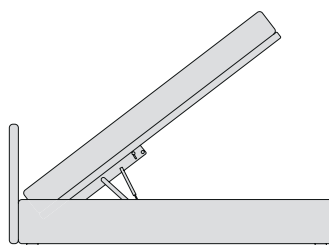

interno in legno



interno in alluminio
only for h29cm

HANDS-FREE solo per h.29 cm / only for h.29cm

apertura del box senza l'uso delle mani e grazie al box completamente in alluminio è privo di pistoncini a vista / The mechanism allows to open the storage box without hands, and thanks to its aluminum structure, the storage box has inner pistons, thus maintaining a top-notch design

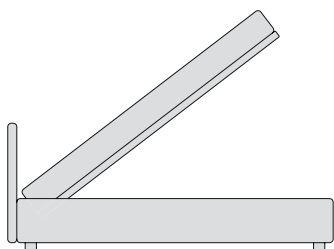

interno in alluminio
only for h29cm

EASY UP

grazie al movimento che mantiene la rete all'interno dello spazio occupato dal letto, ottimizza lo spazio all'interno della stanza / mechanism optimizes the space inside the room thanks to its movement that keeps the slatted base within the space occupied by the bed

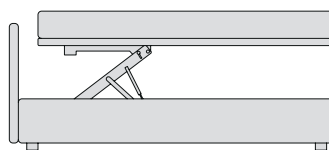

interno in legno



interno in alluminio
only for h29cm

h. 20-29 INCASSO MATERASSO / MATTRESS RECESS

La struttura dei letti Bolzan permette di soddisfare le diverse esigenze di progettazione: l'incasso del materasso nella struttura del letto è personalizzabile in 7 altezze diverse. Non disponibile per le basi con box.

Bolzan beds' structure allows you to meet different design needs: the mattress recess in the bed's structure is customizable in 7 different heights. It is not available for bases with box.

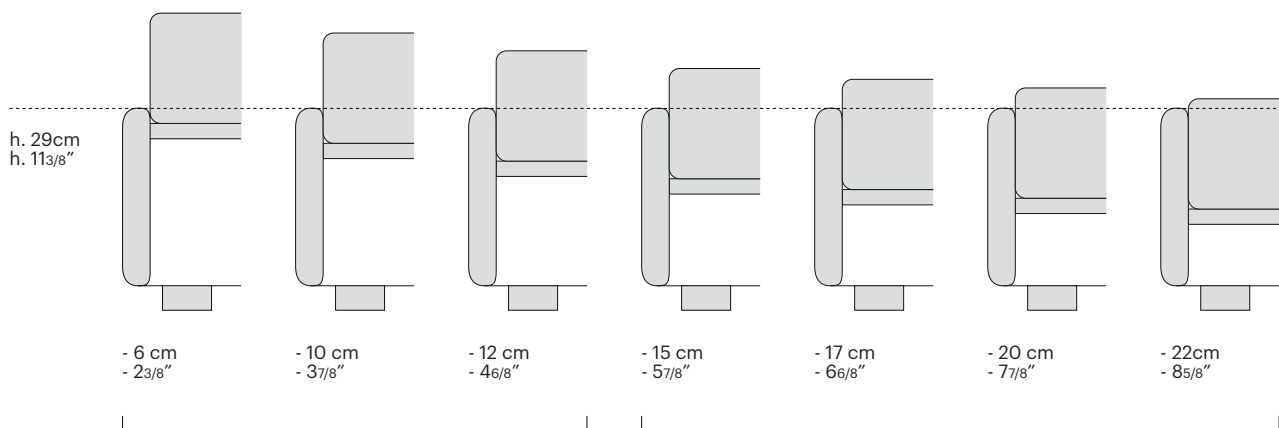

ribassamento disponibile per giroletto h. 20 e h. 29 cm /
mattress recess available for h. 20 and h. 29 cm bedframes

ribassamento disponibile solo per giroletto h. 29 cm /
mattress recess available for h. 29 cm bedframe