

kate

design bolzan LAB



Un letto che invita al riposo oppure alla lettura, grazie ai doppi cuscini della testiera, reclinabili con un semplice gesto. Kate ha un design rigoroso ma un'anima accondiscendente a ogni desiderio. La scelta fra diverse tipologie di sostegno per la base, aumenta le possibilità di personalizzazione.

A bed inviting you to rest or reading, thanks to the double pillows of its headboard, which are reclinable by a simple gesture. Kate has a rigorous design but a consenting spirit to every desire. The choice among various bedbases, increases the tailoring possibilities.

informazioni tecniche / technical info:

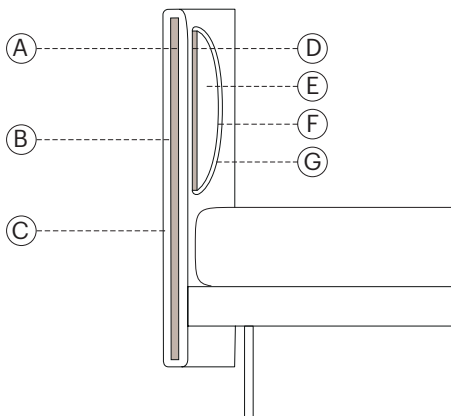

h 9

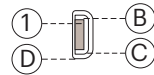

h 20

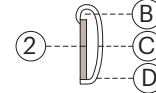

h 29

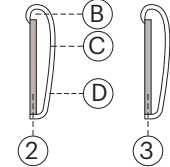

testata / headboard

- A. multistrato curvato di ceiba + MDF 25mm / curved ceiba plywood + 25mm MDF
- B. espanso ignifugo D 25 kg/mc / fire resistant foam D 25 kg/mc
- C. maglina polipropilene 70 gr / 70 g polypropylene mesh
- D. truciolare 18 mm / 18 mm chipboard
- E. espanso ignifugo D 30 kg/mc / fire resistant foam D 30 kg/mc
- F. ovatta siliconata 350g / 350g siliconized
- G. Tela cotone 150g / 150g cotton canvas

giroletti / bedframes

- 1. MDF 40mm / 40mm MDF
- B. espanso ignifugo D 35 kg/mc / fire resistant foam D 35 kg/mc
- C. resinato poliestere ignifugo 100g / 100g fire resistant resined polyester fiber
- D. maglia polipropilene 70g / 70g polypropylene mesh
- 2. listellare abete 22mm 3 strati / 22mm 3-layer fir blockboard
- 3. estruso in alluminio 22mm / 22 mm extruded aluminum

predisposto per materassi / for mattresses:

160 x 200	63" x 78 ⁶ / ₈ "
170 x 200	66 ⁷ / ₈ " x 78 ⁶ / ₈ "
180 x 200	70 ⁷ / ₈ " x 78 ⁶ / ₈ "

153 x 203	60" x 80"	Queen size
193 x 203	76" x 80"	King size

Kate / Firwood structure

Standard feet Vasetto - cover in fabric completely removable and not removable headboard structure cover in leather or ecoleather - adjustable headboard - maximum mattress height 26 cm

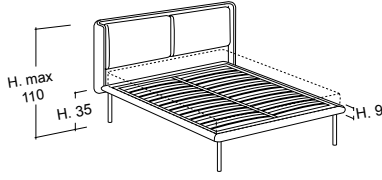
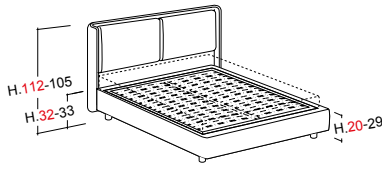
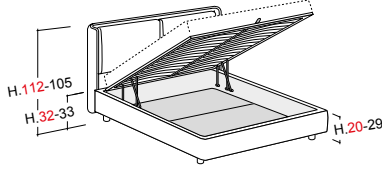
	Mattress	Ext. dimension	Code	D	C	A	Plus	Luxury fabric	Luxury leather	Nuvola fabric	Nuvola leather	TCL	Cover			
													ml	mc	kg	
thin base h.9																
orthopaedic slatted base included carrying slat																
	150x200	180x215	KAL9										7.2	0.62	75	
	153x203 QUEEN 60x80"	180x214	KAQ9										7.2	0.62	75	
	160x200	190x215	KAM9										7.5	0.64	89	
	170x200	200x215	KAF9										7.5	0.67	94	
	180x200	210x215	KAG9										7.8	0.69	102	
	190x200	220x215	KAP9										8.5	0.72	110	
	193x203 KING 76x80"	223x215	KAK9										8.5	0.72	110	
	Loose cover		RKA											8.1	0.02	8
rounded base h.20 - rounded base h.29																
without slatted base (to choose a slatted base see flap on the right)																
	150x200	180x220	KAL29										7.2	0.61	82	
	153x203 QUEEN 60x80"	183x223	KAQ29										7.2	0.61	82	
	160x200	190x220	KAM29										7.5	0.62	83	
	170x200	200x220	KAF29										7.5	0.64	90	
	180x200	210x220	KAG29										7.8	0.66	97	
	190x200	220x220	KAP29										8.4	0.69	106	
193x203 KING 76x80"	223x223	KAK29										8.4	0.69	106		
Loose cover		RKA											8.1	0.02	8	
rounded base h.20 - rounded base h.29 w/BOX																
orthopaedic slatted base included suggested weights for mattresses (see flap on the right)																
	150x200	180x220	KAL29B										7.2	0.85	142	
	153x203 QUEEN 60x80"	183x223	KAQ29B										7.2	0.85	142	
	160x200	190x220	KAM29B										7.5	0.87	148	
	170x200	200x220	KAF29B										7.8	0.9	158	
	180x200	210x220	KAG29B										8.1	0.94	167	
	190x200	220x220	KAP29B										8.4	1	179	
193x203 KING 76x80"	223x223	KAK29B										8.4	1	179		
available inside height in Box 12-18cm			RKA										0.02		8	

Kate / Aluminum structure

Standard feet Vasetto - cover in fabric completely removable and not removable headboard structure cover in leather or ecoleather - adjustable headboard - maximum mattress height 26 cm

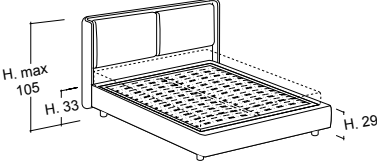
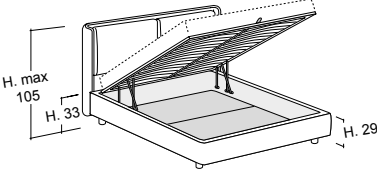
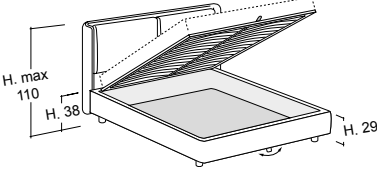
Mattress	Ext. dimension	Code	D	C	A	Plus	Luxury fabric	Luxury leather	Nuvola fabric	Nuvola leather	TCL	Cover			
												ml	mc	kg	
rounded base h.29 without slatted base (to choose a slatted base see flap on the right)															
	150x200	180x220	KAL29A									7.2	0.61	85	
	153x203 QUEEN 60X80"	183x223	KAQ29A									7.2	0.61	85	
	160x200	190x220	KAM29A									7.5	0.62	86	
	170x200	200x220	KAF29A									7.5	0.64	93	
	180x200	210x220	KAG29A									7.8	0.66	101	
	190x200	220x220	KAP29A									8.4	0.69	111	
	193x203 KING 76X80"	223x223	KAK29A									8.4	0.69	111	
	Loose cover		RKAA									8.1	0.02	8	
rounded base h.29 w/BOX orthopaedic slatted base included suggested weights for mattresses (see flap on the right)															
	150x200	180x220	KAL29BA									7.2	0.85	145	
	153x203 QUEEN 60X80"	183x223	KAQ29BA									7.2	0.85	145	
	160x200	190x220	KAM29BA									7.5	0.87	151	
	170x200	200x220	KAF29BA									7.8	0.9	161	
	180x200	210x220	KAG29BA									8.1	0.94	171	
	190x200	220x220	KAP29BA									8.4	1	184	
	193x203 KING 76X80"	223x223	KAK29BA									8.4	1	184	
available inside height in Box 18cm	Loose cover		RKAA									0.02		8	
rounded base h.29 w/HANDS FREE BOX orthopaedic slatted base included Specify mattress weight (see flap on the right)															
	150x200	180x223	KAL29BHF									7.2	0.89	151	
	153x203 QUEEN 60X80"	183x226	KAQ29BHF									7.2	0.89	151	
	160x200	190x223	KAM29BHF									7.5	0.91	157	
	170x200	200x223	KAF29BHF									7.8	0.94	167	
	180x200	210x223	KAG29BHF									8.1	0.98	178	
	190x200	220x223	KAP29BHF									8.4	1.04	194	
	193x203 KING 76X80"	223x226	KAK29BHF									8.4	1.04	194	
available inside height in Box 18cm	Loose cover		RKAHF									0.02		8	

GIROLETTI E PIEDINI / BEDFRAMES AND FEET

pieдини in legno / wooden feet:

pieдини realizzati in legno di frassino con possibilità di essere tinti, verniciati ral o foderati in tessuto a scelta.

ash wood legs with the possibility of being dyed, RAL varnished or lined with fabric (of your choice)

pieдини in metallo / metal feet:

pieдини realizzati in metallo con possibilità di essere verniciati effetto ottone o colori ral.

metal legs with the possibility of being painted in brass effect or RAL varnished.

bedframe h.9 cm



cilindro

H 26 cm 10²/₈"



vasetto

H 26 cm 10²/₈"



vasetto inclinato

H 26 cm 10²/₈"

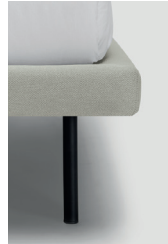

tubino

H 26 cm 10²/₈"



lamina

H 26 cm 10²/₈"



arco

H 26 cm 10²/₈"

bedframe h.20 cm



cilindro

H 12,5 cm 4⁷/₈"



vasetto

H 12,5 cm 4⁷/₈"



tubino

H 12,5 cm 4⁷/₈"



lamina

H 15 cm 5⁷/₈"

bedframe h.29 cm



vasetto h. 4cm

H 4 cm 1⁵/₈"



vasetto h. 9-12,5 cm

H 9 cm 3⁴/₈"

H 12,5 cm 4⁷/₈"



cipolla

H 8 cm 3¹/₈"

finiture legno tinto / lacquered wood finishes:



noce / walnut



ciliegio / cherry



rovere / oak



wengè

finiture metallo / metal finishes:



ottone satinato /
brushed brass

finiture laccati ral / ral lacquered finishes:



bianco / white
RAL 9010



nero / black
RAL 9011



grigio / grey
RAL 7044



marrone / brown
RAL 8019



rosso / red
RAL 3005



verde / green
RAL 6020



blu / blue
RAL 5008

h. 20-29 SISTEMA CONTENITORE / BOX SYSTEM



box

BOX

apertura basic del box grazie ad un semplice sistema a leva / basic opening of storage box thanks to a simple lever system

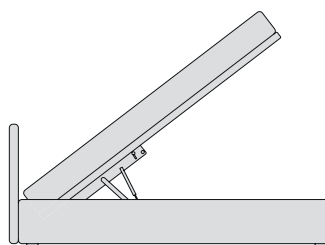

interno in legno



interno in alluminio
only for h29cm

HANDS-FREE solo per h.29 cm / only for h.29cm

apertura del box senza l'uso delle mani e grazie al box completamente in alluminio è privo di pistoncini a vista / The mechanism allows to open the storage box without hands, and thanks to its aluminum structure, the storage box has inner pistons, thus maintaining a top-notch design

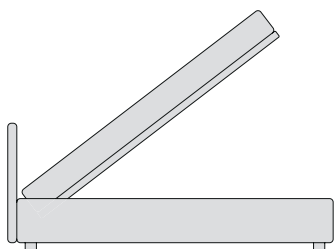

interno in alluminio
only for h29cm

EASY UP

grazie al movimento che mantiene la rete all'interno dello spazio occupato dal letto, ottimizza lo spazio all'interno della stanza / mechanism optimizes the space inside the room thanks to its movement that keeps the slatted base within the space occupied by the bed

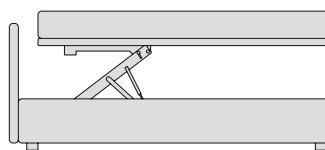

interno in legno



interno in alluminio
only for h29cm

h. 20-29 INCASSO MATERASSO / MATTRESS RECESS

La struttura dei letti Bolzan permette di soddisfare le diverse esigenze di progettazione: l'incasso del materasso nella struttura del letto è personalizzabile in 7 altezze diverse. Non disponibile per le basi con box.

Bolzan beds' structure allows you to meet different design needs: the mattress recess in the bed's structure is customizable in 7 different heights. It is not available for bases with box.

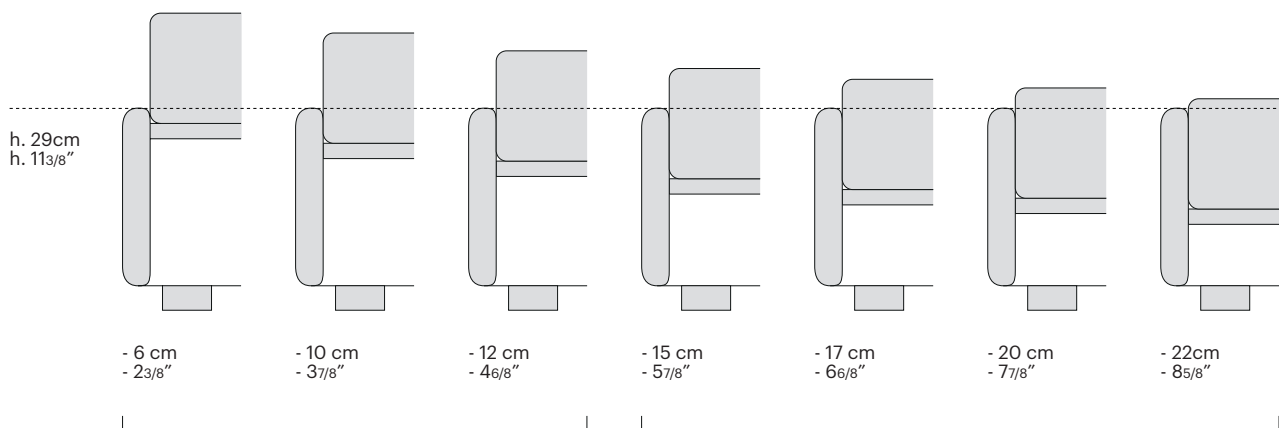

ribassamento disponibile per giroletto h. 20 e h. 29 cm /
mattress recess available for h. 20 and h. 29 cm bedframes

ribassamento disponibile solo per giroletto h. 29 cm /
mattress recess available for h. 29 cm bedframe