

# vanity

design bolzan LAB



Fresca sobrietà di linee e volumi, per un letto che si trova perfettamente a suo agio negli ambienti classici come negli spazi più moderni. La testiera arrotondata si ispira alla tradizione, idealizzandola in un segno grafico pieno e accogliente. La trasversalità del progetto viene ulteriormente enfatizzata dalla possibilità di scegliere la base con contenitore.

Fresh sobriety of lines and volumes, for a bed that is perfect in classic environments as well as in more modern spaces. The rounded headboard is inspired by tradition, idealizing it in a full and welcoming graphic sign. The transversality of the project is further emphasized by the possibility of choosing the base with storage box.

## informazioni tecniche / technical info:

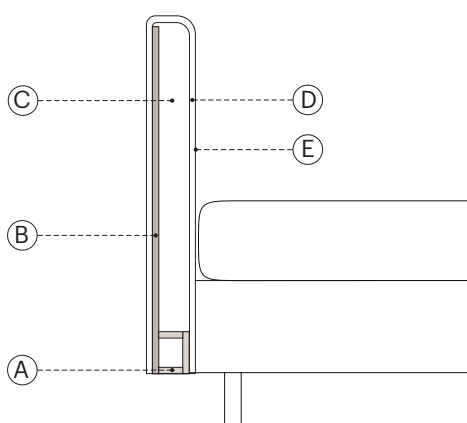

h 20

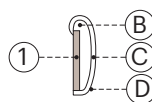

h 29

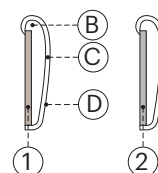

### testata / headboard

- A. listellare di abete 3 strati 22mm / 22mm 3-layer fir blockboard
- B. truciolare 18 mm / 18 mm multilayer
- C. espanso ignifugo D 30 kg/mc / fire resistant foam D 30 kg/mc
- D. resinato poliestere ignifugo 100g / 100g fire retardant resin polyester fiber
- E. maglia polipropilene 70g / 70g polypropylene mesh

### giroletti / bedframes

- 1. listellare abete 22mm 3 strati / 22mm 3-layer fir blockboard
- 2. estruso in alluminio 22mm / 22 mm extruded aluminum
- B. espanso ignifugo D 35 kg/mc / fire resistant foam D 35 kg/mc
- C. resinato poliestere ignifugo 100g / 100g fire resistant resined polyester fiber
- D. maglia polipropilene 70g / 70g polypropylene mesh

### predisposto per materassi / for mattresses:

90	x	200	35 <sup>3</sup> / <sub>8</sub> "	x	78 <sup>6</sup> / <sub>8</sub> "	
100	x	200	39 <sup>3</sup> / <sub>8</sub> "	x	78 <sup>6</sup> / <sub>8</sub> "	
120	x	200	47 <sup>2</sup> / <sub>8</sub> "	x	78 <sup>6</sup> / <sub>8</sub> "	
140	x	200	55 <sup>1</sup> / <sub>8</sub> "	x	78 <sup>6</sup> / <sub>8</sub> "	
160	x	200	63"	x	78 <sup>6</sup> / <sub>8</sub> "	
170	x	200	66 <sup>7</sup> / <sub>8</sub> "	x	78 <sup>6</sup> / <sub>8</sub> "	
180	x	200	70 <sup>7</sup> / <sub>8</sub> "	x	78 <sup>6</sup> / <sub>8</sub> "	
137	x	190	54"	x	75"	<b>F</b> ull double size
153	x	203	60"	x	80"	<b>Q</b> ueen size
193	x	203	76"	x	80"	<b>K</b> ing size

### personalizzazioni disponibili / available customizations:



gonnellina / skirt gonnellina / skirt chic

# Vanity / Firwood structure

Standard feet Vasetto - removable headboard cover in fabric and non removable in leather or eco-leather

	Mattress	Ext. dimension	Code	D	C	A	Plus	Luxury fabric	Luxury leather	Nuvola fabric	Nuvola leather	TCL	Cover		kg
													ml	mc	
rounded base h.20 - rounded base h.29 without slatted base (to choose a slatted base see flap on the right)	90x200	108x218	<b>VAS29</b>										5.5	0.32	47
	100x200	118x218	<b>VAC29</b>										6	0.33	50
	120x200	138x218	<b>VAD29</b>										6.5	0.35	59
	135x190	153x208	<b>VAI29</b>										6.9	0.36	62
	137x190 DOUBLE 54X75	155x208	<b>VAE29</b>										6.9	0.36	62
	140x200	158x218	<b>VAU29</b>										7	0.37	63
	150x200	168x218	<b>VAL29</b>										7.5	0.38	68
	153x203 QUEEN 60X80	171x221	<b>VAQ29</b>										7.5	0.38	68
	160x200	178x218	<b>VAM29</b>										8	0.39	69
	170x200	188x218	<b>VAF29</b>										8.3	0.4	72
	180x200	198x218	<b>VAG29</b>										8.5	0.42	74
	190x200	208x218	<b>VAP29</b>										9	0.45	80
	193x203 KING 76X80	211x221	<b>VAK29</b>										9	0.45	80
		Loose cover		<b>RVA</b>											0.02
rounded base h.20 - rounded base h.29 w/BOX orthopaedic slatted base included suggested weights for mattresses (see flap on the right)	90x200	108x218	<b>VAS29B</b>										5.5	0.45	87
	100x200	118x218	<b>VAC29B</b>										6	0.48	96
	120x200	138x218	<b>VAD29B</b>										6.5	0.53	110
	135x190	153x208	<b>VAI29B</b>										6.9	0.58	115
	137x190 DOUBLE 54X75	155x208	<b>VAE29B</b>										6.9	0.58	115
	140x200	158x218	<b>VAU29B</b>										7	0.59	116
	150x200	168x218	<b>VAL29B</b>										7.5	0.63	122
	153x203 QUEEN 60X80	171x221	<b>VAQ29B</b>										7.5	0.63	122
	160x200	178x218	<b>VAM29B</b>										8	0.64	124
	170x200	188x218	<b>VAF29B</b>										8.3	0.67	130
	180x200	198x218	<b>VAG29B</b>										8.5	0.69	136
	190x200	208x218	<b>VAP29B</b>										9	0.72	144
	193x203 KING 76X80	211x221	<b>VAK29B</b>										9	0.72	144
	available inside height in Box 12-18cm	Loose cover		<b>RVA</b>											0.02
rounded base h.20 - rounded base h.29 w/easy-up BOX orthopaedic slatted base included suggested weights for mattresses (see flap on the right)	90x200	108x218	<b>VAS29BE</b>										5.5	0.49	97
	100x200	118x218	<b>VAC29BE</b>										6	0.52	106
	120x200	138x218	<b>VAD29BE</b>										6.5	0.57	120
	135x190	153x208	<b>VAI29BE</b>										6.9	0.62	125
	137x190 DOUBLE 54X75	155x208	<b>VAE29BE</b>										6.9	0.62	125
	140x200	158x218	<b>VAU29BE</b>										7	0.63	126
	150x200	168x218	<b>VAL29BE</b>										7.5	0.67	132
	153x203 QUEEN 60X80	171x221	<b>VAQ29BE</b>										7.5	0.67	132
	160x200	178x218	<b>VAM29BE</b>										8	0.68	134
	170x200	188x218	<b>VAF29BE</b>										8.3	0.71	140
	180x200	198x218	<b>VAG29BE</b>										8.5	0.73	146
	190x200	208x218	<b>VAP29BE</b>										9	0.76	154
	193x203 KING 76X80	211x221	<b>VAK29BE</b>										9	0.76	154
	available inside height in Box 12-18cm	Loose cover		<b>RVA</b>											0.02

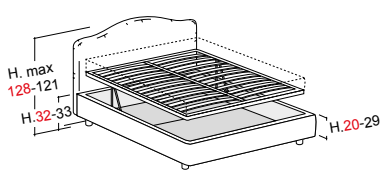
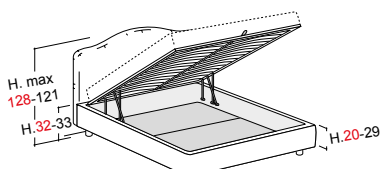
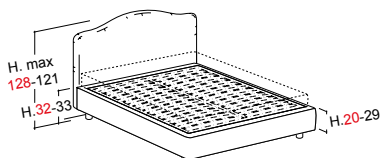

# Vanity / Aluminum structure

Standard feet Vasetto - removable headboard cover in fabric and non removable in leather or eco-leather

	Mattress	Ext. dimension	Code	D	C	A	Plus	Luxury fabric	Luxury leather	Nuvola fabric	Nuvola leather	TCL	Cover			
													ml	mc	kg	
<b>rounded base h.29</b> without slatted base (to choose a slatted base see flap on the right)	90x200	108x218	<b>VAS29A</b>										5.5	0.32	43	
	100x200	118x218	<b>VAC29A</b>										6	0.33	46	
	120x200	138x218	<b>VAD29A</b>										6.5	0.35	52	
	135x190	153x208	<b>VAI29A</b>										6.9	0.36	56	
	137x190 DOUBLE 54X75"	155x208	<b>VAE29A</b>										6.9	0.36	56	
	140x200	158x218	<b>VAU29A</b>										7	0.37	57	
	150x200	168x218	<b>VAL29A</b>										7.5	0.38	61	
	153x203 QUEEN 60X80"	171x221	<b>VAQ29A</b>										7.5	0.38	61	
	160x200	178x218	<b>VAM29A</b>										8	0.39	62	
	170x200	188x218	<b>VAF29A</b>										8.3	0.4	65	
	180x200	198x218	<b>VAG29A</b>										8.5	0.42	71	
	190x200	208x218	<b>VAP29A</b>										9	0.45	77	
	193x203 KING 76X80"	211x221	<b>VAK29A</b>										9	0.45	77	
		<b>Loose cover</b>		<b>RVAA</b>											0.02	8
<b>rounded base h.29 w/box</b> orthopaedic slatted base included suggested weights for mattresses (see flap on the right)	90x200	108x218	<b>VAS29BA</b>										5.5	0.45	88	
	100x200	118x218	<b>VAC29BA</b>										6	0.48	97	
	120x200	138x218	<b>VAD29BA</b>										6.5	0.53	111	
	135x190	153x208	<b>VAI29BA</b>										6.9	0.58	117	
	137x190 DOUBLE 54X75"	155x208	<b>VAE29BA</b>										6.9	0.58	117	
	140x200	158x218	<b>VAU29BA</b>										7	0.59	118	
	150x200	168x218	<b>VAL29BA</b>										7.5	0.63	125	
	153x203 QUEEN 60X80"	171x221	<b>VAQ29BA</b>										7.5	0.63	125	
	160x200	178x218	<b>VAM29BA</b>										8	0.64	127	
	170x200	188x218	<b>VAF29BA</b>										8.3	0.67	133	
	180x200	198x218	<b>VAG29BA</b>										8.5	0.69	141	
	190x200	208x218	<b>VAP29BA</b>										9	0.72	149	
	193x203 KING 76X80"	211x221	<b>VAK29BA</b>										9	0.72	149	
		<b>Loose cover</b>		<b>RVAA</b>											0.02	8
<b>rounded base h.29 w/easy-up box</b> orthopaedic slatted base included suggested weights for mattresses (see flap on the right)	90x200	108x218	<b>VAS29BEA</b>										5.5	0.49	98	
	100x200	118x218	<b>VAC29BEA</b>										6	0.52	107	
	120x200	138x218	<b>VAD29BEA</b>										6.5	0.57	122	
	135x190	153x208	<b>VAI29BEA</b>										6.9	0.62	127	
	137x190 DOUBLE 54X75"	155x208	<b>VAE29BEA</b>										6.9	0.62	127	
	140x200	158x218	<b>VAU29BEA</b>										7	0.63	129	
	150x200	168x218	<b>VAL29BEA</b>										7.5	0.67	135	
	153x203 QUEEN 60X80"	171x221	<b>VAQ29BEA</b>										7.5	0.67	135	
	160x200	178x218	<b>VAM29BEA</b>										8	0.68	137	
	170x200	188x218	<b>VAF29BEA</b>										8.3	0.71	143	
	180x200	198x218	<b>VAG29BEA</b>										8.5	0.73	151	
	190x200	208x218	<b>VAP29BEA</b>										9	0.76	159	
	193x203 KING 76X80"	211x221	<b>VAK29BEA</b>										9	0.76	159	
		<b>Loose cover</b>		<b>RVAA</b>											0.02	8
<b>rounded base h.29 w/HANDS FREE BOX</b> orthopaedic slatted base included Specify mattress weight (see flap on the right)	150x200	168x221	<b>VAL29BHF</b>										7.5	0.67	131	
	153x203 QUEEN 60X80"	171x224	<b>VAQ29BHF</b>										7.5	0.67	131	
	160x200	178x221	<b>VAM29BHF</b>										8	0.68	133	
	170x200	188x221	<b>VAF29BHF</b>										8.3	0.71	135	
	180x200	198x221	<b>VAG29BHF</b>										8.5	0.73	141	
	190x200	208x221	<b>VAP29BHF</b>										9	0.76	148	
	193x203 KING 76X80"	211x224	<b>VAK29BHF</b>										9	0.76	148	
		<b>Loose cover</b>		<b>RVAHF</b>											0.02	157

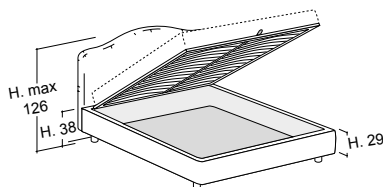
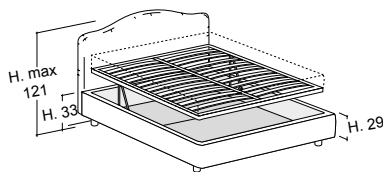
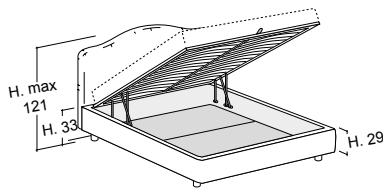
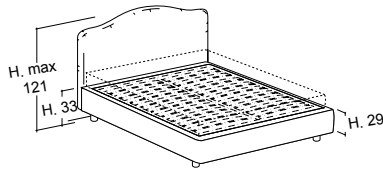

## GIROLETTI E PIEDINI / BEDFRAMES AND FEET

### bedframe h.9 cm



cilindro  
H 26 cm 10<sup>2</sup>/<sub>8</sub>"



vasetto  
H 26 cm 10<sup>2</sup>/<sub>8</sub>"



vasetto inclinato  
H 26 cm 10<sup>2</sup>/<sub>8</sub>"



tubino  
H 26 cm 10<sup>2</sup>/<sub>8</sub>"



lamina  
H 26 cm 10<sup>2</sup>/<sub>8</sub>"



arco  
H 26 cm 10<sup>2</sup>/<sub>8</sub>"

### bedframe h.20 cm



cilindro  
H 12,5 cm 4<sup>7</sup>/<sub>8</sub>"



vasetto  
H 12,5 cm 4<sup>7</sup>/<sub>8</sub>"



tubino  
H 12,5 cm 4<sup>7</sup>/<sub>8</sub>"



lamina  
H 15 cm 5<sup>7</sup>/<sub>8</sub>"

### bedframe h.29 cm



vasetto h. 4cm  
H 4 cm 1<sup>5</sup>/<sub>8</sub>"



vasetto h. 9-12,5 cm  
H 9 cm 3<sup>4</sup>/<sub>8</sub>"  
H 12,5 cm 4<sup>7</sup>/<sub>8</sub>"



cipolla  
H 8 cm 3<sup>1</sup>/<sub>8</sub>"

### pedini in legno / wooden feet:

pedini realizzati in legno di pincopallo con possibilità di essere tinti, verniciati ral o foderati in tessuto a scelta.

pedini realizzati in legno di pincopallo con possibilità di essere tinti, verniciati ral o foderati in tessuto a scelta.

### finiture legno tinto / lacquered wood finishes:



noce / walnut



ciliegio / cherry



rovere / oak



wengè

### pedini in metallo / metal feet:

pedini realizzati in acciaio con possibilità di essere verniciati effetto ottone o colori ral.

pedini realizzati in acciaio con possibilità di essere verniciati effetto ottone o colori ral.

### finiture metallo / metal finishes:



ottone satinato /  
brushed brass

### finiture laccati ral / ral lacquered finishes:



bianco / white  
RAL 9010



perla / pearl  
RAL 1013



nero / black  
RAL 9011



grigio / grey  
RAL 7044



marrone / brown  
RAL 8019



rosso / red  
RAL 3005



verde / green  
RAL 6020



blu / blue  
RAL 5008

## h. 20-29 SISTEMA CONTENITORE / BOX SYSTEM



box

### BOX

apertura basic del box grazie ad un semplice sistema a leva / basic opening of storage box thanks to a simple lever system

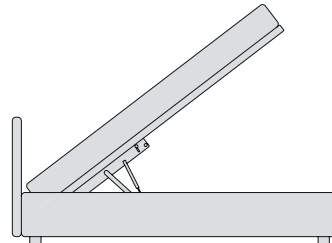

interno in legno



interno in alluminio

### HANDS-FREE

apertura del box senza l'uso delle mani e grazie al box completamente in alluminio è privo di pistoncini a vista / The mechanism allows to open the storage box without hands, and thanks to its aluminum structure, the storage box has inner pistons, thus maintaining a top-notch design

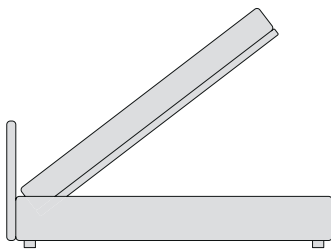

interno in alluminio

### EASY UP

grazie al movimento che mantiene la rete all'interno dello spazio occupato dal letto, ottimizza lo spazio all'interno della stanza / mechanism optimizes the space inside the room thanks to its movement that keeps the slatted base within the space occupied by the bed

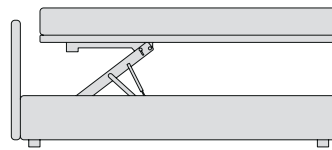

interno in legno



interno in alluminio

## h. 20-29 INCASSO MATERASSO / MATTRESS RECESS

La struttura dei letti Bolzan permette di soddisfare le diverse esigenze di progettazione: l'incasso del materasso nella struttura del letto è personalizzabile in 7 altezze diverse. Non disponibile per le basi con box.

Bolzan beds' structure allows you to meet different design needs: the mattress recess in the bed's structure is customizable in 7 different heights. It is not available for bases with box.

