

# lorca

design bolzan LAB



Confezionati come un abito elegante, i cuscini della testata sono gli elementi più distintivi di lorca. Un progetto che ricerca la bellezza nella semplicità, interpretando le lezioni del migliore design per giungere a un risultato impeccabile. La possibilità di scegliere fra diverse tipologie di piedini, aggiunge un tocco di personalizzazione in più.

Tailored as an elegant dress, the headboard cushions are the most distinctive elements of lorca. A project seeking beauty in its simplicity, interpreting best design lessons to achieve an impeccable result. The possibility to choose between different types of feet adds an extra touch of personalization.

## informazioni tecniche / technical info:

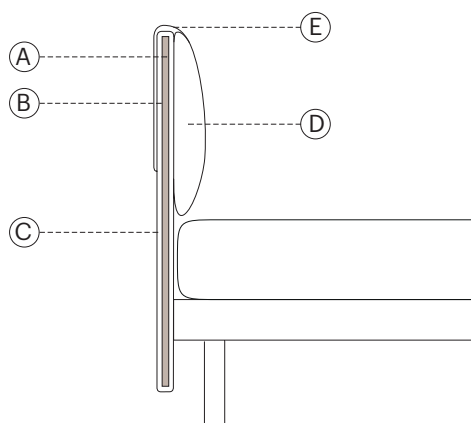

### testata / headboard

- A. truciolare 20mm / 20mm chipboard
- B. espanso ignifugo D 25 kg/mc / fire resistant foam D 25 kg/mc
- C. maglia polipropilene 70g / 70g polypropylene mesh
- D. ovatta siliconata 350g / 350g siliconized
- E. tela cotone 150 gr/mq / cotton canvas 150 gr/m2

### h 9

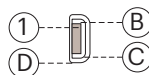

### h 20

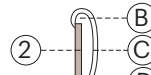

### h 29

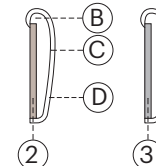

### giroletti / bedframes

- 1. MDF 40mm / 40mm MDF
- B. espanso ignifugo D 35 kg/mc / fire resistant foam D 35 kg/mc
- C. resinato poliestere ignifugo 100g / 100g fire resistant resined polyester fiber
- D. maglia polipropilene 70g / 70g polypropylene mesh
- 2. listellare abete 22mm 3 strati / 22mm 3-layer fir blockboard
- 3. estruso in alluminio 22mm / 22 mm extruded aluminum

## predisposto per materassi / for mattresses:

90	x	200	35 <sup>3</sup> / <sub>8</sub> "	x	78 <sup>6</sup> / <sub>8</sub> "	
100	x	200	39 <sup>3</sup> / <sub>8</sub> "	x	78 <sup>6</sup> / <sub>8</sub> "	
120	x	200	47 <sup>2</sup> / <sub>8</sub> "	x	78 <sup>6</sup> / <sub>8</sub> "	
140	x	200	55 <sup>1</sup> / <sub>8</sub> "	x	78 <sup>6</sup> / <sub>8</sub> "	
160	x	200	63"	x	78 <sup>6</sup> / <sub>8</sub> "	
170	x	200	66 <sup>7</sup> / <sub>8</sub> "	x	78 <sup>6</sup> / <sub>8</sub> "	
180	x	200	70 <sup>7</sup> / <sub>8</sub> "	x	78 <sup>6</sup> / <sub>8</sub> "	
137	x	190	54"	x	75"	<b>F</b> ull double size
153	x	203	60"	x	80"	<b>Q</b> ueen size
193	x	203	76"	x	80"	<b>K</b> ing size

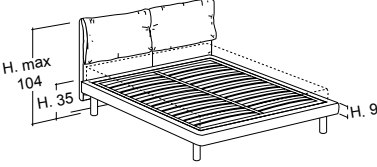
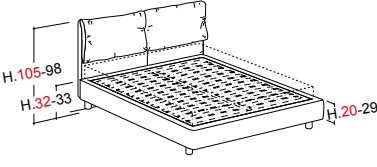
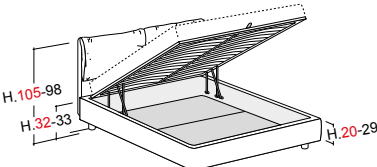
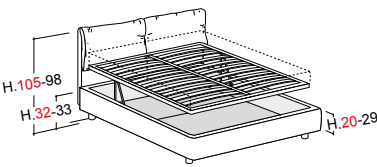
	Mattress	Ext. dimension	Code	D	C	A	Plus	Luxury fabric	Luxury leather	Nuvola fabric	Nuvola leather	TCL	Cover			
													ml	mc	kg	
<b>thin base h.9</b> orthopaedic slatted base included carrying slat  	90x200	108x215	<b>IOS9</b>										7	0.33	56	
	100x200	118x215	<b>IOC9</b>										7.5	0.35	60	
	120x200	138x215	<b>IOD9</b>										8	0.39	67	
	135x190	153x205	<b>IOI9</b>										8.4	0.44	71	
	137x190 DOUBLE 54X75"	153x205	<b>IOE9</b>										8.4	0.44	71	
	140x200	158x215	<b>IOU9</b>										8.5	0.45	71	
	150x200	168x215	<b>IOL9</b>										8.8	0.48	83	
	153x203 QUEEN 60X80"	168x215	<b>IOQ9</b>										8.8	0.48	83	
	160x200	178x215	<b>IOM9</b>										9	0.5	83	
	170x200	188x215	<b>IOF9</b>										9	0.51	86	
	180x200	198x215	<b>IOG9</b>										9.5	0.53	92	
	190x200	208x215	<b>IOP9</b>										10	0.53	98	
	193x203 KING 76X80"	211x215	<b>IOK9</b>										10	0.53	98	
		<b>Loose cover</b>		<b>RIO</b>												
	<b>rounded base h.20 - rounded base h.29</b> without slatted base (to choose a slatted base see flap on the right) Composition  	90x200	108x219	<b>IOS29</b>										7	0.32	74
		100x200	118x219	<b>IOC29</b>										7.5	0.33	77
		120x200	138x219	<b>IOD29</b>										8	0.36	83
135x190		153x209	<b>IOI29</b>										8.4	0.39	87	
137x190 DOUBLE 54X75"		153x209	<b>IOE29</b>										8.4	0.39	87	
140x200		158x219	<b>IOU29</b>										8.5	0.39	87	
150x200		168x219	<b>IOL29</b>										8.8	0.4	95	
153x203 QUEEN 60X80"		171x222	<b>IOQ29</b>										8.8	0.4	95	
160x200		178x219	<b>IOM29</b>										9	0.41	95	
170x200		188x219	<b>IOF29</b>										9	0.42	101	
180x200		198x219	<b>IOG29</b>										9.5	0.44	107	
190x200		208x219	<b>IOP29</b>										10	0.47	113	
193x203 KING 76X80"		211x222	<b>IOK29</b>										10	0.47	113	
		<b>Loose cover</b>		<b>RIO</b>												
<b>rounded base h.20 - rounded base h.29 w/BOX</b> orthopaedic slatted base included suggested weights for mattresses (see flap on the right)  		90x200	108x219	<b>IOS29B</b>										7	0.45	95
		100x200	118x219	<b>IOC29B</b>										7.5	0.48	103
		120x200	138x219	<b>IOD29B</b>										8	0.54	113
	135x190	153x209	<b>IOI29B</b>										8.4	0.6	116	
	137x190 DOUBLE 54X75"	153x209	<b>IOE29B</b>										8.4	0.6	116	
	140x200	158x219	<b>IOU29B</b>										8.5	0.61	117	
	150x200	168x219	<b>IOL29B</b>										8.8	0.64	123	
	153x203 QUEEN 60X80"	171x222	<b>IOQ29B</b>										8.8	0.64	123	
	160x200	178x219	<b>IOM29B</b>										9	0.67	125	
	170x200	188x219	<b>IOF29B</b>										9	0.69	133	
	180x200	198x219	<b>IOG29B</b>										9.5	0.72	140	
	190x200	208x219	<b>IOP29B</b>										10	0.76	150	
	193x203 KING 76X80"	211x222	<b>IOK29B</b>										10	0.76	150	
	available inside height in Box 12-18cm	<b>Loose cover</b>		<b>RIO</b>											0.02	8
	<b>rounded base h.20 - rounded base h.29 w/easy-up BOX</b> orthopaedic slatted base included suggested weights for mattresses (see flap on the right) - <b>to use the mechanism remove the headbo- ard cushions</b>  	90x200	108x219	<b>IOS29BE</b>										7	0.49	105
		100x200	118x219	<b>IOC29BE</b>										7.5	0.52	113
		120x200	138x219	<b>IOD29BE</b>										8	0.58	123
135x190		153x209	<b>IOI29BE</b>										8.4	0.64	126	
137x190 DOUBLE 54X75"		153x209	<b>IOE29BE</b>										8.4	0.64	126	
140x200		158x219	<b>IOU29BE</b>										8.5	0.65	127	
150x200		168x219	<b>IOL29BE</b>										8.8	0.69	132	
153x203 QUEEN 60X80"		171x222	<b>IOQ29BE</b>										8.8	0.69	132	
160x200		178x219	<b>IOM29BE</b>										9	0.71	135	
170x200		188x219	<b>IOF29BE</b>										9	0.73	143	
180x200		198x219	<b>IOG29BE</b>										9.5	0.76	150	
190x200		208x219	<b>IOP29BE</b>										10	0.8	160	
193x203 KING 76X80"		211x222	<b>IOK29BE</b>										10	0.8	160	
available inside height in Box 12-18cm		<b>Loose cover</b>		<b>RIO</b>											0.02	8

# lorca / Aluminum structure

Standard feet Vasetto - completely removable cover in fabric and non removable headboard cover in leather or ecoleather

	Mattress	Ext. dimension	Code	D	C	A	Plus	Luxury fabric	Luxury leather	Nuvola fabric	Nuvola leather	TCL	Cover			
													ml	mc	kg	
<b>rounded base h.29</b> without slatted base (to choose a slatted base see flap on the right)	90x200	108x219	<b>IOS29A</b>										7	0.32	51	
	100x200	118x219	<b>IOC29A</b>										7.5	0.33	53	
	120x200	138x219	<b>IOD29A</b>										8	0.36	55	
	135x190	153x209	<b>IOI29A</b>										8.4	0.39	57	
	137x190 DOUBLE 54X75"	153x209	<b>IOE29A</b>										8.4	0.39	57	
	140x200	158x219	<b>IOU29A</b>										8.5	0.39	58	
	150x200	168x219	<b>IOL29A</b>										8.8	0.4	61	
	153x203 QUEEN 60X80"	171x222	<b>IOQ29A</b>										8.8	0.4	61	
	160x200	178x219	<b>IOM29A</b>										9	0.41	63	
	170x200	188x219	<b>IOF29A</b>										9	0.42	68	
	180x200	198x219	<b>IOG29A</b>										9.5	0.44	74	
	190x200	208x219	<b>IOP29A</b>										10	0.47	82	
	193x203 KING 76X80"	211x222	<b>IOK29A</b>										10	0.47	82	
		Loose cover		<b>RIOA</b>											0.02	8
	<b>rounded base h.29 w/BOX</b> orthopaedic slatted base included suggested weights for mattresses (see flap on the right)	90x200	108x219	<b>IOS29BA</b>										7	0.45	96
100x200		118x219	<b>IOC29BA</b>										7.5	0.48	104	
120x200		138x219	<b>IOD29BA</b>										8	0.54	114	
135x190		153x209	<b>IOI29BA</b>										8.4	0.6	118	
137x190 DOUBLE 54X75"		153x209	<b>IOE29BA</b>										8.4	0.6	118	
140x200		158x219	<b>IOU29BA</b>										8.5	0.61	119	
150x200		168x219	<b>IOL29BA</b>										8.8	0.64	126	
153x203 QUEEN 60X80"		171x222	<b>IOQ29BA</b>										8.8	0.64	126	
160x200		178x219	<b>IOM29BA</b>										9	0.67	128	
170x200		188x219	<b>IOF29BA</b>										9	0.69	136	
180x200		198x219	<b>IOG29BA</b>										9.5	0.72	144	
190x200		208x219	<b>IOP29BA</b>										10	0.76	155	
193x203 KING 76X80"		211x222	<b>IOK29BA</b>										10	0.76	155	
		Loose cover		<b>RIBA</b>											0.02	8
<b>rounded base h.29 w/easy-up BOX</b> orthopaedic slatted base included suggested weights for mattresses (see flap on the right) - to use the mechanism remove the headboard cushions		90x200	108x219	<b>IOS29BEA</b>										7	0.49	106
	100x200	118x219	<b>IOC29BEA</b>										7.5	0.52	114	
	120x200	138x219	<b>IOD29BEA</b>										8	0.58	124	
	135x190	153x209	<b>IOI29BEA</b>										8.4	0.64	128	
	137x190 DOUBLE 54X75"	153x209	<b>IOE29BEA</b>										8.4	0.64	128	
	140x200	158x219	<b>IOU29BEA</b>										8.5	0.65	129	
	150x200	168x219	<b>IOL29BEA</b>										8.8	0.69	135	
	153x203 QUEEN 60X80"	171x222	<b>IOQ29BEA</b>										8.8	0.69	135	
	160x200	178x219	<b>IOM29BEA</b>										9	0.71	138	
	170x200	188x219	<b>IOF29BEA</b>										9	0.73	146	
	180x200	198x219	<b>IOG29BEA</b>										9.5	0.76	154	
	190x200	208x219	<b>IOP29BEA</b>										10	0.8	165	
	193x203 KING 76X80"	211x222	<b>IOK29BEA</b>										10	0.8	165	
		Loose cover		<b>RIBA</b>											0.02	8
	<b>rounded base h.29 w/HANDS FREE BOX</b> orthopaedic slatted base included Specify mattress weight (see flap on the right)	150x200	168x222	<b>IOL29BHF</b>										8.8	0.69	132
153x203 QUEEN 60X80"		171x225	<b>IOQ29BHF</b>										8.8	0.69	132	
160x200		178x222	<b>IOM29BHF</b>										9	0.71	134	
170x200		188x222	<b>IOF29BHF</b>										9	0.73	144	
180x200		198x222	<b>IOG29BHF</b>										9.5	0.76	151	
190x200		208x222	<b>IOP29BHF</b>										10	0.8	163	
193x203 KING 76X80"		211x225	<b>IOK29BHF</b>										10	0.8	163	
		Loose cover		<b>RIBHF</b>											0.02	8

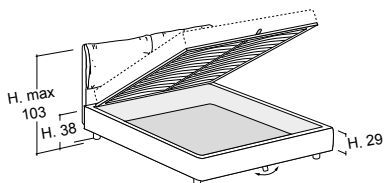
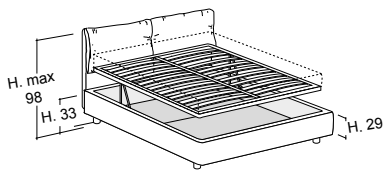
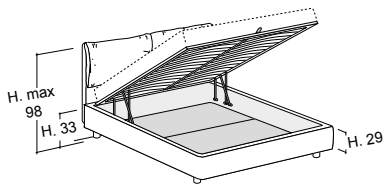
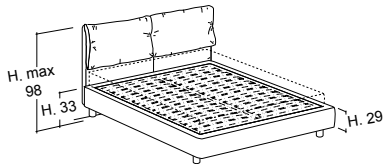

## GIROLETTI E PIEDINI / BEDFRAMES AND FEET

### pieдини in legno / wooden feet:

pieдини realizzati in legno di frassino con possibilità di essere tinti, verniciati ral o foderati in tessuto a scelta.

ash wood legs with the possibility of being dyed, RAL varnished or lined with fabric (of your choice)

### pieдини in metallo / metal feet:

pieдини realizzati in metallo con possibilità di essere verniciati effetto ottone o colori ral.

metal legs with the possibility of being painted in brass effect or RAL varnished.

### bedframe h.9 cm



cilindro  
H 26 cm 10<sup>2</sup>/<sub>8</sub>"



vasetto  
H 26 cm 10<sup>2</sup>/<sub>8</sub>"



vasetto inclinato  
H 26 cm 10<sup>2</sup>/<sub>8</sub>"

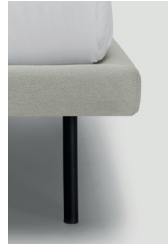

tubino  
H 26 cm 10<sup>2</sup>/<sub>8</sub>"



lamina  
H 26 cm 10<sup>2</sup>/<sub>8</sub>"



arco  
H 26 cm 10<sup>2</sup>/<sub>8</sub>"

### bedframe h.20 cm



cilindro  
H 12,5 cm 4<sup>7</sup>/<sub>8</sub>"



vasetto  
H 12,5 cm 4<sup>7</sup>/<sub>8</sub>"



tubino  
H 12,5 cm 4<sup>7</sup>/<sub>8</sub>"



lamina  
H 15 cm 5<sup>7</sup>/<sub>8</sub>"

### bedframe h.29 cm



vasetto h. 4cm  
H 4 cm 1<sup>5</sup>/<sub>8</sub>"



vasetto h. 9-12,5 cm  
H 9 cm 3<sup>4</sup>/<sub>8</sub>"  
H 12,5 cm 4<sup>7</sup>/<sub>8</sub>"



cipolla  
H 8 cm 3<sup>1</sup>/<sub>8</sub>"

### finiture legno tinto / lacquered wood finishes:



noce / walnut



ciliegio / cherry



rovere / oak



wengè

### finiture metallo / metal finishes:



ottone satinato /  
brushed brass

### finiture laccati ral / ral lacquered finishes:



bianco / white  
RAL 9010



nero / black  
RAL 9011



grigio / grey  
RAL 7044



marrone / brown  
RAL 8019



rosso / red  
RAL 3005



verde / green  
RAL 6020



blu / blue  
RAL 5008

## h. 20-29 SISTEMA CONTENITORE / BOX SYSTEM



box

### BOX

apertura basic del box grazie ad un semplice sistema a leva / basic opening of storage box thanks to a simple lever system

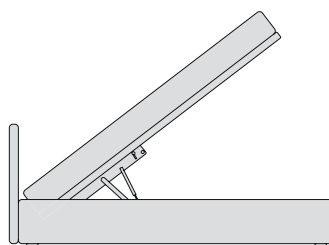

interno in legno



interno in alluminio  
only for h29cm

### HANDS-FREE solo per h.29 cm / only for h.29cm

apertura del box senza l'uso delle mani e grazie al box completamente in alluminio è privo di pistoncini a vista / The mechanism allows to open the storage box without hands, and thanks to its aluminum structure, the storage box has inner pistons, thus maintaining a top-notch design

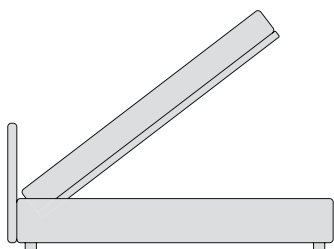

interno in alluminio  
only for h29cm

### EASY UP

grazie al movimento che mantiene la rete all'interno dello spazio occupato dal letto, ottimizza lo spazio all'interno della stanza / mechanism optimizes the space inside the room thanks to its movement that keeps the slatted base within the space occupied by the bed

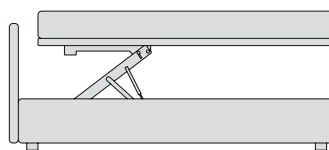

interno in legno



interno in alluminio  
only for h29cm

## h. 20-29 INCASSO MATERASSO / MATTRESS RECESS

La struttura dei letti Bolzan permette di soddisfare le diverse esigenze di progettazione: l'incasso del materasso nella struttura del letto è personalizzabile in 7 altezze diverse. Non disponibile per le basi con box.

Bolzan beds' structure allows you to meet different design needs: the mattress recess in the bed's structure is customizable in 7 different heights. It is not available for bases with box.

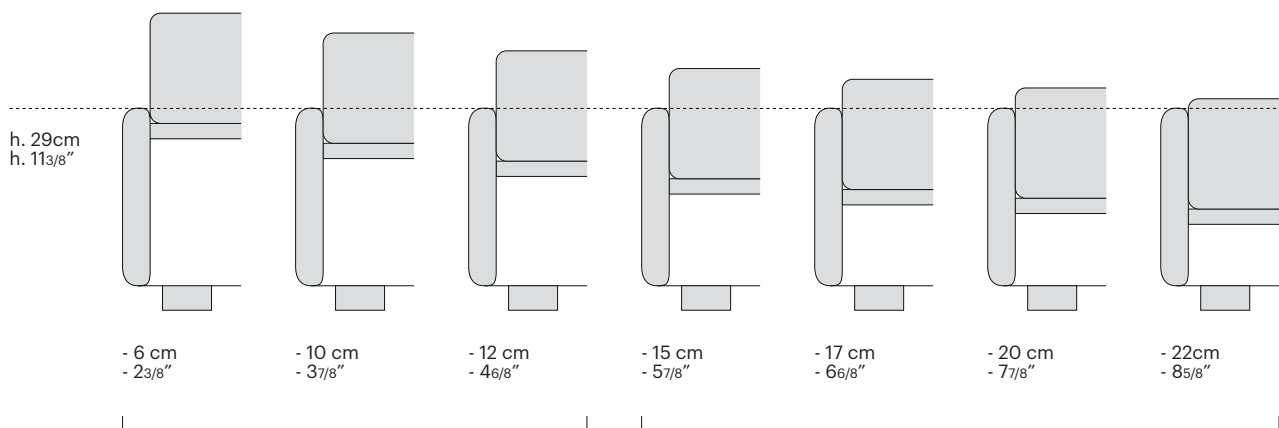

ribassamento disponibile per giroletto h. 20 e h. 29 cm /  
mattress recess available for h. 20 and h. 29 cm bedframes

ribassamento disponibile solo per giroletto h. 29 cm /  
mattress recess available for h. 29 cm bedframe