

sailor

design bolzan LAB



Riscoprire la tradizione per viverla in modo nuovo. La testiera intrecciata di Sailor è realizzata a mano, con tecniche arcaiche che ci trasportano in mondi lontani. Il sapore artigianale di questa creazione, non dimentica le coordinate della modernità e permette di esplorare le più diverse ambientazioni.

Rediscover tradition to live it in a new way. Sailor's braided headboard is handmade with archaic techniques, transporting us to distant worlds. The artisan flavor of this creation does not forget the coordinates of modernity and allows you to explore the most different settings.

informazioni tecniche / technical info:

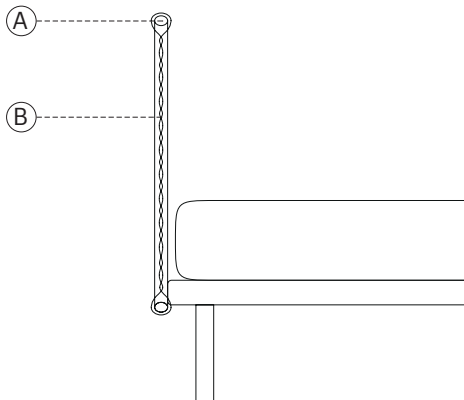

testata / headboard

A. tubo acciaio 25 mm x 10 mm / 25 mm x 10 mm steel tube
B. cordino intrecciato polipropilene Ø 6mm / Ø 6mm braided polypropylene cord

h 5

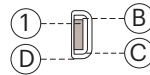

h 29

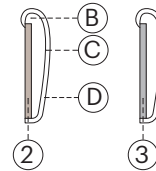

giroletti / bedframes

1. MDF 40mm / 40mm MDF
B. espanso ignifugo D 35 kg/mc / fire resistant foam D 35 kg/mc
C. resinato poliestere ignifugo 100g / 100g fire resistant resined polyester fiber
D. maglia polipropilene 70g / 70g polypropylene mesh
2. listellare abete 22mm 3 strati / 22mm 3-layer fir blockboard
3. estruso in alluminio 22mm / 22 mm extruded aluminum

predisposto per materassi / for mattresses:

| | |
|-----------|---|
| 160 x 200 | 63" x 78 ⁶ / ₈ " |
| 170 x 200 | 66 ⁷ / ₈ " x 78 ⁶ / ₈ " |
| 180 x 200 | 70 ⁷ / ₈ " x 78 ⁶ / ₈ " |

| | | |
|-----------|-----------|------------------|
| 193 x 203 | 76" x 80" | King size |
|-----------|-----------|------------------|

Sailor / Firwood structure

Standard feet Vasetto - completely removable cover for base- available in the following colors: cream, beige, taupe, bordeaux, blue and green bottle

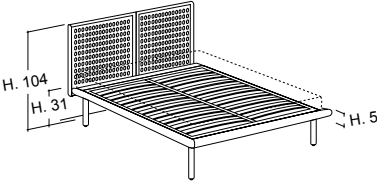
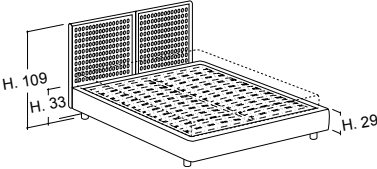
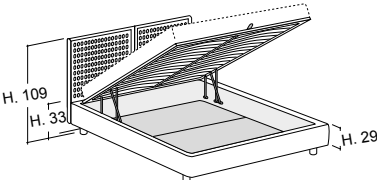
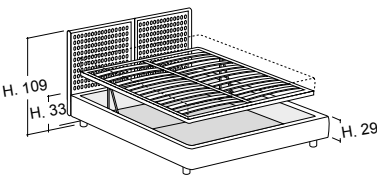
| | Mattress | Ext. dimension | Code | D | C | A | Plus | Luxury fabric | Luxury leather | Nuvola fabric | Nuvola leather | TCL | Cover | | | |
|--|-------------------------------------|----------------|----------------|---|---|---|------|---------------|----------------|---------------|----------------|-----|-------|------|-----|--|
| | | | | | | | | | | | | | ml | mc | kg | |
| smile base orthopaedic slatted base included carrying slat | | | | | | | | | | | | | | | | |
|  | 160x200 | 174x217 | SAM | | | | | | | | | | 3 | 0.41 | 54 | |
| | 170x200 | 184x217 | SAF | | | | | | | | | | 3 | 0.43 | 56 | |
| | 180x200 | 194x217 | SAG | | | | | | | | | | 3 | 0.44 | 59 | |
| | 190x200 | 204x217 | SAK | | | | | | | | | | 3 | 0.46 | 64 | |
| | 193x203 KING 76X80" | 207x217 | SAK | | | | | | | | | | 3 | 0.46 | 64 | |
| | Loose cover | | RSA | | | | | | | | | | | 0.02 | 8 | |
| rounded base h.29 without slatted base (to choose a slatted base see flap on the right) | | | | | | | | | | | | | | | | |
|  | 160x200 | 174x219 | SAM29 | | | | | | | | | | 3 | 0.33 | 48 | |
| | 170x200 | 184x219 | SAF29 | | | | | | | | | | 3.5 | 0.34 | 51 | |
| | 180x200 | 194x219 | SAG29 | | | | | | | | | | 3.5 | 0.35 | 54 | |
| | 190x200 | 204x219 | SAP29 | | | | | | | | | | 3.5 | 0.36 | 58 | |
| | 193x203 KING 76X80" | 207x222 | SAK29 | | | | | | | | | | 3.5 | 0.36 | 58 | |
| | Loose cover | | RSA | | | | | | | | | | | 0.02 | 8 | |
| rounded base h.29 w/BOX orthopaedic slatted base included suggested weights for mattresses (see flap on the right) | | | | | | | | | | | | | | | | |
|  | 160x200 | 174x219 | SAM29B | | | | | | | | | | 3 | 0.59 | 113 | |
| | 170x200 | 184x219 | SAF29B | | | | | | | | | | 3.5 | 0.62 | 119 | |
| | 180x200 | 194x219 | SAG29B | | | | | | | | | | 3.5 | 0.63 | 124 | |
| | 190x200 | 204x219 | SAP29B | | | | | | | | | | 3.5 | 0.67 | 130 | |
| | 193x203 KING 76X80" | 207x222 | SAK29B | | | | | | | | | | 3.5 | 0.67 | 130 | |
| | available inside height in Box 18cm | | RSA | | | | | | | | | | | 0.02 | 8 | |
| rounded base h.29 w/easy-up BOX orthopaedic slatted base included suggested weights for mattresses (see flap on the right) | | | | | | | | | | | | | | | | |
|  | 160x200 | 174x219 | SAM29BE | | | | | | | | | | 3 | 0.63 | 123 | |
| | 170x200 | 184x219 | SAF29BE | | | | | | | | | | 3.5 | 0.66 | 129 | |
| | 180x200 | 194x219 | SAG29BE | | | | | | | | | | 3.5 | 0.67 | 134 | |
| | 190x200 | 204x219 | SAP29BE | | | | | | | | | | 3.5 | 0.71 | 140 | |
| | 193x203 KING 76X80" | 207x222 | SAK29BE | | | | | | | | | | 3.5 | 0.71 | 140 | |
| | available inside height in Box 18cm | | RSA | | | | | | | | | | | 0.02 | 8 | |

Sailor / Aluminum structure

Standard feet Vasetto - completely removable cover - available only in the following fabrics: bub, bull, canvas 2, capri, cosme, domino, favignana, hot, las vegas, little blake, marluch, matala, mystic, parigi, proust, rally, rosa, piquant, pop, s.moritz, snob, taurus, velvet e wow.

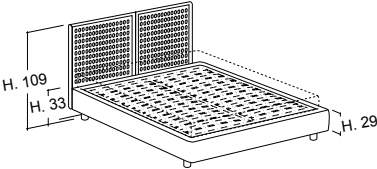
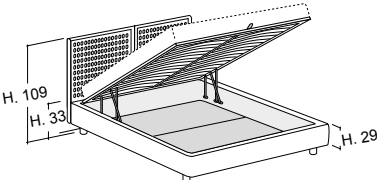
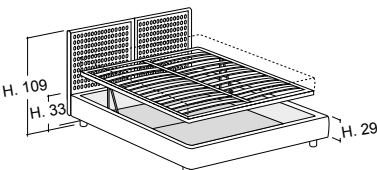
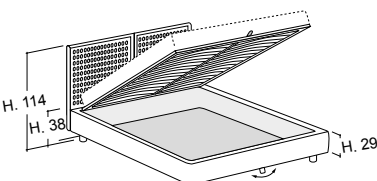
| | Mattress | Ext. dimension | Code | D | C | A | Plus | Luxury fabric | Luxury leather | Nuvola fabric | Nuvola leather | TCL | Cover | | |
|---|------------------------|----------------|-----------------|---|---|---|------|---------------|----------------|---------------|----------------|-----|-------|------|-----|
| | | | | | | | | | | | | | ml | mc | kg |
| rounded base h.29 | | | | | | | | | | | | | | | |
| without slatted base (to choose a slatted base see flap on the right) | | | | | | | | | | | | | | | |
|  | 160x200 | 174x219 | SAM29A | | | | | | | | | | 9 | 0.33 | 51 |
| | 170x200 | 184x219 | SAF29A | | | | | | | | | | 9.5 | 0.34 | 54 |
| | 180x200 | 194x219 | SAG29A | | | | | | | | | | 10 | 0.35 | 59 |
| | 190x200 | 204x219 | SAP29A | | | | | | | | | | 10.5 | 0.36 | 63 |
| | 193x203 KING 76X80" | 207x222 | SAK29A | | | | | | | | | | 10.5 | 0.36 | 63 |
| | Loose cover | | RSAA | | | | | | | | | | | 0.02 | |
| rounded base h.29 w/BOX | | | | | | | | | | | | | | | |
| orthopaedic slatted base included suggested weights for mattresses (see flap on the right) | | | | | | | | | | | | | | | |
|  | 160x200 | 174x219 | SAM29BA | | | | | | | | | | 9 | 0.59 | 116 |
| | 170x200 | 184x219 | SAF29BA | | | | | | | | | | 9.5 | 0.62 | 122 |
| | 180x200 | 194x219 | SAG29BA | | | | | | | | | | 10 | 0.63 | 128 |
| | 190x200 | 204x219 | SAP29BA | | | | | | | | | | 10.5 | 0.67 | 135 |
| | 193x203 KING 76X80" | 207x222 | SAK29BA | | | | | | | | | | 10.5 | 0.67 | 135 |
| | Loose cover | | RSAA | | | | | | | | | | | 0.02 | |
| available inside height in Box 18cm | | | | | | | | | | | | | | | |
| rounded base h.29 w/easy/up BOX | | | | | | | | | | | | | | | |
| orthopaedic slatted base included suggested weights for mattresses (see flap on the right) | | | | | | | | | | | | | | | |
|  | 160x200 | 174x219 | SAM29BEA | | | | | | | | | | 9 | 0.63 | 126 |
| | 170x200 | 184x219 | SAF29BEA | | | | | | | | | | 9.5 | 0.66 | 132 |
| | 180x200 | 194x219 | SAG29BEA | | | | | | | | | | 10 | 0.67 | 138 |
| | 190x200 | 204x219 | SAP29BEA | | | | | | | | | | 10.5 | 0.71 | 145 |
| | 193x203 KING 76X80" | 207x222 | SAK29BEA | | | | | | | | | | 10.5 | 0.71 | 145 |
| | Loose cover | | RSAA | | | | | | | | | | | 0.02 | |
| available inside height in Box 18cm | | | | | | | | | | | | | | | |
| rounded base h.29 w/HANDS FREE BOX | | | | | | | | | | | | | | | |
| orthopaedic slatted base included Specify mattress weight (see flap on the right) | | | | | | | | | | | | | | | |
|  | 160x200 | 174x222 | SAM29BHF | | | | | | | | | | 9 | 0.63 | 122 |
| | 170x200 | 184x222 | SAF29BHF | | | | | | | | | | 9.5 | 0.66 | 128 |
| | 180x200 | 194x222 | SAG29BHF | | | | | | | | | | 10 | 0.67 | 135 |
| | 190x200 | 204x222 | SAP29BHF | | | | | | | | | | 10.5 | 0.71 | 143 |
| | 193x203 KING 76X80" | 207x225 | SAK29BHF | | | | | | | | | | 10.5 | 0.71 | 143 |
| | Loose cover | | RSAHF | | | | | | | | | | | 0.02 | |
| available inside height in Box 18cm | | | | | | | | | | | | | | | |

GIROLETTI E PIEDINI / BEDFRAMES AND FEET

pieдини in legno / wooden feet:

pieдини realizzati in legno di frassino con possibilità di essere tinti, verniciati ral o foderati in tessuto a scelta.

ash wood legs with the possibility of being dyed, RAL varnished or lined with fabric (of your choice)

pieдини in metallo / metal feet:

pieдини realizzati in metallo con possibilità di essere verniciati effetto ottone o colori ral.

metal legs with the possibility of being painted in brass effect or RAL varnished.

bedframe h.9 cm



cilindro
H 26 cm 10²/₈"



vasetto
H 26 cm 10²/₈"



vasetto inclinato
H 26 cm 10²/₈"

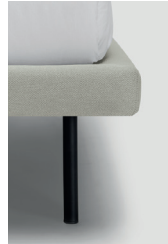

tubino
H 26 cm 10²/₈"



lamina
H 26 cm 10²/₈"



arco
H 26 cm 10²/₈"

bedframe h.20 cm



cilindro
H 12,5 cm 4⁷/₈"



vasetto
H 12,5 cm 4⁷/₈"



tubino
H 12,5 cm 4⁷/₈"



lamina
H 15 cm 5⁷/₈"

bedframe h.29 cm



vasetto h. 4cm
H 4 cm 1⁵/₈"



vasetto h. 9-12,5 cm
H 9 cm 3⁴/₈"
H 12,5 cm 4⁷/₈"



cipolla
H 8 cm 3¹/₈"

finiture legno tinto / lacquered wood finishes:



noce / walnut



ciliegio / cherry



rovere / oak



wengè

finiture metallo / metal finishes:



ottone satinato /
brushed brass

finiture laccati ral / ral lacquered finishes:



bianco / white
RAL 9010



nero / black
RAL 9011



grigio / grey
RAL 7044



marrone / brown
RAL 8019



rosso / red
RAL 3005



verde / green
RAL 6020



blu / blue
RAL 5008

h. 20-29 SISTEMA CONTENITORE / BOX SYSTEM



box

BOX

apertura basic del box grazie ad un semplice sistema a leva / basic opening of storage box thanks to a simple lever system

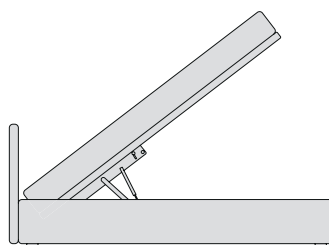

interno in legno



interno in alluminio
only for h29cm

HANDS-FREE solo per h.29 cm / only for h.29cm

apertura del box senza l'uso delle mani e grazie al box completamente in alluminio è privo di pistoncini a vista / The mechanism allows to open the storage box without hands, and thanks to its aluminum structure, the storage box has inner pistons, thus maintaining a top-notch design

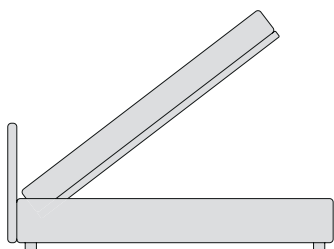

interno in alluminio
only for h29cm

EASY UP

grazie al movimento che mantiene la rete all'interno dello spazio occupato dal letto, ottimizza lo spazio all'interno della stanza / mechanism optimizes the space inside the room thanks to its movement that keeps the slatted base within the space occupied by the bed

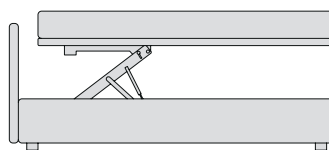

interno in legno



interno in alluminio
only for h29cm

h. 20-29 INCASSO MATERASSO / MATTRESS RECESS

La struttura dei letti Bolzan permette di soddisfare le diverse esigenze di progettazione: l'incasso del materasso nella struttura del letto è personalizzabile in 7 altezze diverse. Non disponibile per le basi con box.

Bolzan beds' structure allows you to meet different design needs: the mattress recess in the bed's structure is customizable in 7 different heights. It is not available for bases with box.

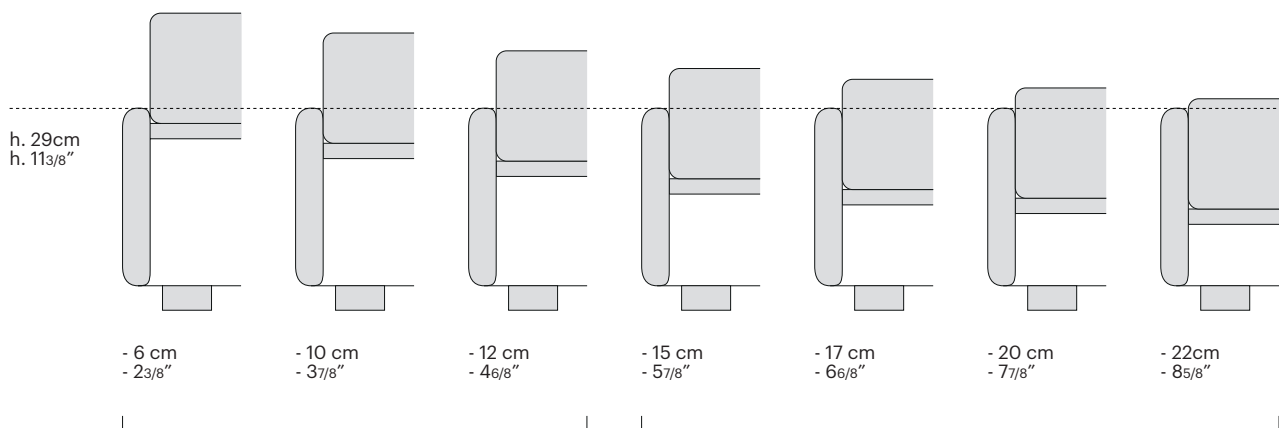

ribassamento disponibile per giroletto h. 20 e h. 29 cm /
mattress recess available for h. 20 and h. 29 cm bedframes

ribassamento disponibile solo per giroletto h. 29 cm /
mattress recess available for h. 29 cm bedframe