

# IOLA

by e-ggs



Iola vive il Design con un approccio internazionale, concentrandosi sull'ergonomia delle forme, mantenendo un aspetto curato e caratterizzante. Abbiamo dato alla scocca la forma di un guscio, producendola in poliuretano espanso. Sotto consiglio dei più esigenti, poi, le abbiamo tirato le orecchie così sono usciti due grandi braccioli. Iola sa di moda, ma si propone come un classico contemporaneo.

Iola shows off design with an international approach, focusing on the ergonomics of the form, ensuring a careful look, one with character. We have given the body the shape of a shell, producing it in expanded polyurethane. Then, on the advice of the hardest to please, we pulled the wings and then the two large arms came out. Iola hints at fashion but comes across as a modern classic.

**GAMBE IN LEGNO | WOODEN LEGS**

lunghezza | width: 52 cm

larghezza | depth: 58,2 cm

altezza | height: 83 cm

altezza del sedile | seat height: 46,5 cm

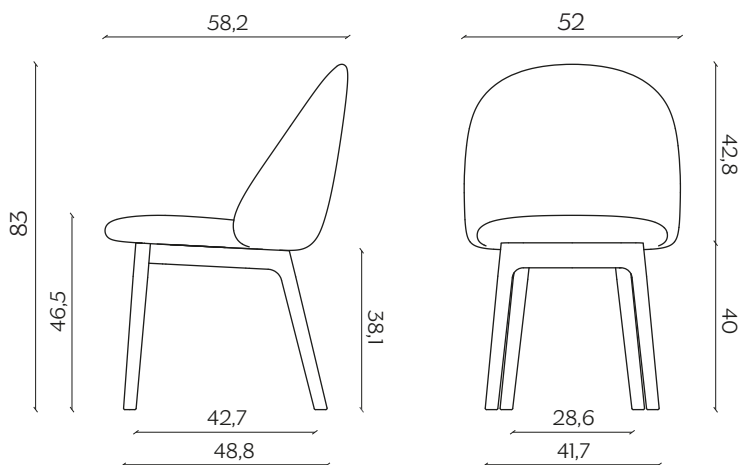

**UFFICIO | OFFICE**

lunghezza | width: 52 cm

larghezza | depth: 58 cm

altezza | height: 83 cm

altezza del sedile | seat height: 46 cm

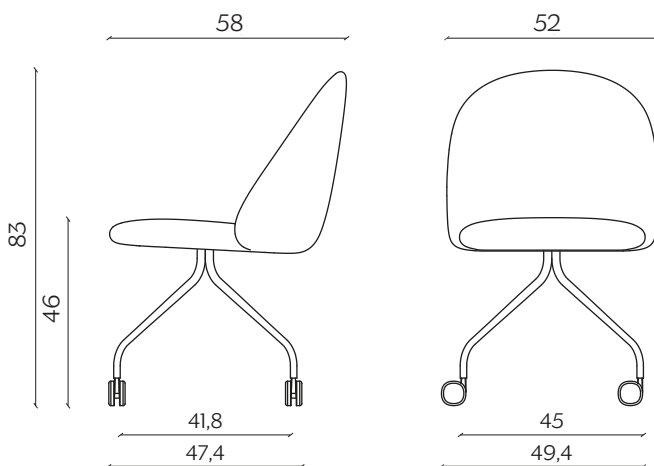

**BASIC | BASIC**  
lunghezza | width: 52 cm  
larghezza | depth: 58 cm  
altezza | height: 83 cm  
altezza del sedile | seat height: 47 cm

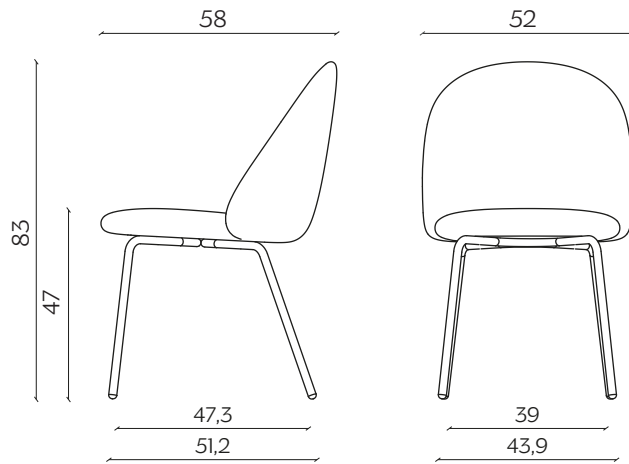

# FINITURE | FINISHES

## GAMBE | LEGS

### Legno | Wood



Frassino  
Ash



Frassino Nero  
Black Ash

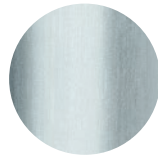

Zincato  
Zinc-coated

### Metallo | Metal

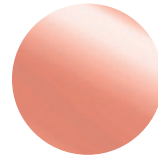

Rame  
Copper

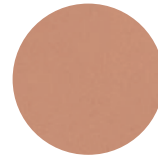

Oro Rosa Opaco  
Rose Gold Matt

### Laccato | Lacquer

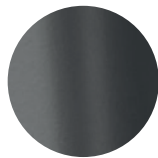

Laccato Antracite  
Anthracite Lacquered



Laccato Nero  
Black Lacquered

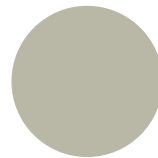

Laccato Grigio Seta  
Silk Grey Lacquered

# FINITURE | FINISHES

## TESSUTI | FABRICS

A

### Salò

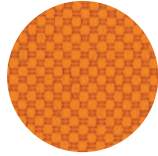

Arancio  
Orange

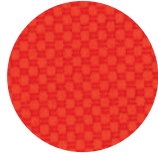

Rosso  
Red



Marmellata  
Jam



Grigio Chiaro  
Light Grey



Marrone  
Brown

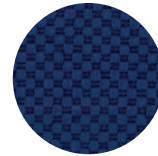

Blu Notte  
Midnight Blue

### Loop

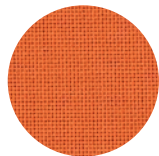

Arancione  
Orange

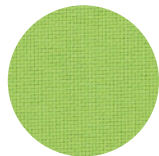

Lime

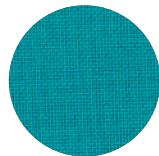

Turchese  
Turquoise

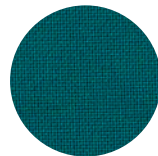

Ottanio  
Teal Green

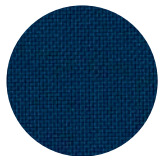

Blu Scuro  
Dark Blue



Testa di Moro  
Dark Brown

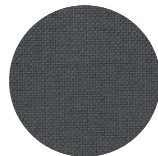

Grigio Fumo  
Smoke Grey

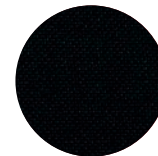

Nero  
Black

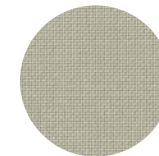

Avorio  
Ivory

# TESSUTI | FABRICS

A

## Tramè



Beije

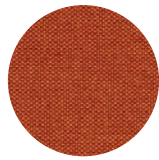

Arancio  
Orange

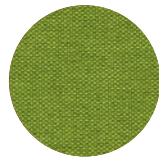

Mela  
Apple

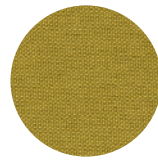

Senape  
Mustard

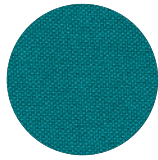

Pavone  
Peacock

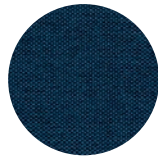

Blu Elettrico  
Electric Blue



Nero  
Black



Crigio Scuro  
Dark Grey

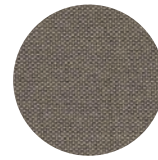

Tortora  
Dove Grey

## Madrid

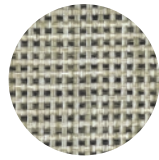

Burro  
Butter

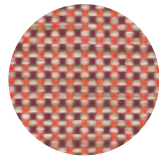

Melograno  
Pomegranate



Menta  
Mint

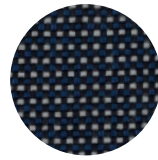

Notte  
Night

# FINITURE | FINISHES

## TESSUTI | FABRICS

B

### Kvadrat Relate



Rosa  
Pink

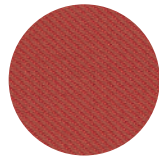

Rosso  
Red

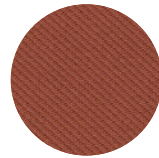

Terra  
Ground

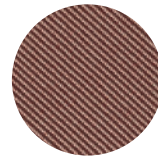

Snack

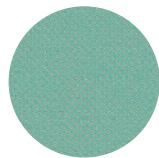

Menta  
Mint

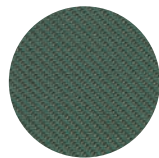

Verde Bosco  
Forest Green

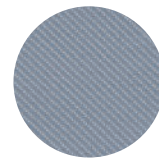

Nuvolo  
Cloudy

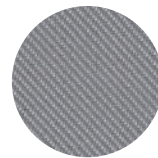

Grigio  
Grey

### Lanee

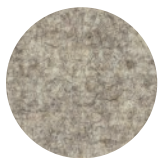

Grigio  
Grey

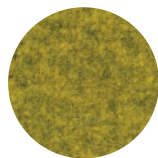

Giallo  
Yellow

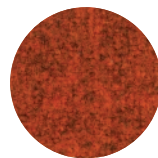

Rosso  
Red

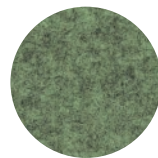

Menta  
Mint

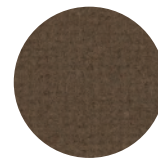

Marrone  
Brown

## TESSUTI | FABRICS

B

### Torrilana Cubbio

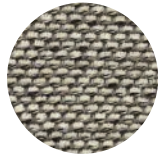

Sale e Pepe  
Salt and Pepper

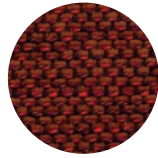

Ambra  
Amber

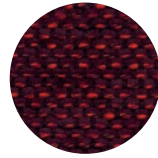

Bordeaux

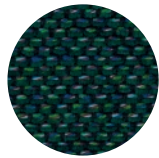

Verde Petrolio  
Petrol Green

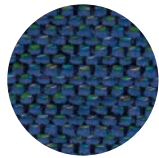

Blu Elettrico  
Electric Blue



Castagna  
Walnut

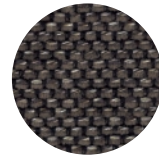

Tortora  
Dove Grey

### Mesh

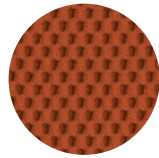

Rosso Corallo  
Coral Red

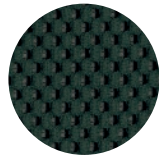

Verde Salvia  
Sage Green

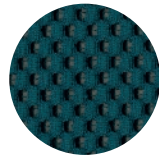

Foglia di Tè  
Teal

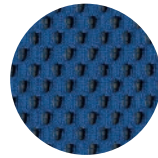

Blu Neon  
Neon Blue



# FINITURE | FINISHES

## TESSUTI | FABRICS

C

### Shelter Velvet



Crema  
Cream



Rosa Intenso  
Intense Rose



Terra di Siena  
Burnt Sienna



Cammello  
Camel



Verde  
Green

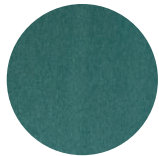

Turchese  
Turquoise



Blu Notte  
Midnight Blue



Testa di Moro  
Dark Brown

### Kvadrat Field 2

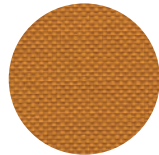

Zafferano  
Saffron-Yellow

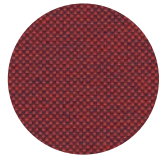

Ciliegia  
Cherry

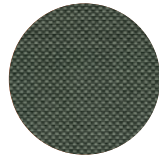

Menta  
Mint

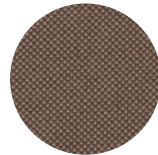

Nocciola  
Hazel

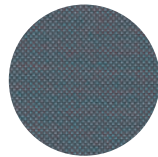

Zucchero  
Sugar

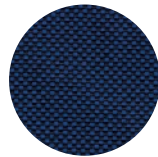

Blu  
Blue

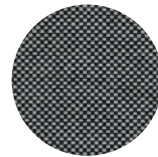

Sale e Pepe  
Salt and Pepper

### Torrilana Brionne



Black and White

## TESSUTI | FABRICS

C

### Vescom Harding

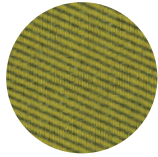

Ciallo  
Yellow

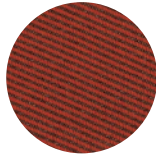

Rosso  
Red

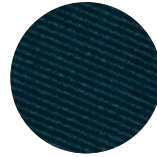

Petrolio  
Blue-Green

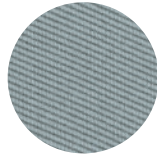

Grigio Chiaro  
Light Grey

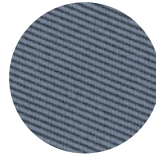

Nuvolo  
Cloudy

### Vescom Rolla

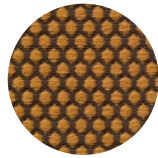

Mostarda  
Mustard

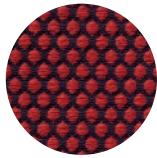

Ciliegia  
Cherry

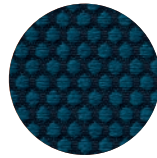

Blu Pavone  
Peacock

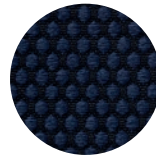

Blu Notte  
Midnight Blue

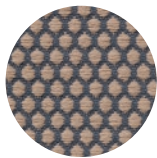

Latte  
Steamed Milk

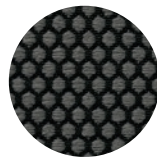

Antracite  
Anthracite

### Torrilana Rakam



Bacca  
Berry

# FINITURE | FINISHES

## TESSUTI | FABRICS

D

### Cloud



Panna  
Cream



Noce  
Walnut

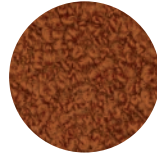

Nocciola  
Hazelnut

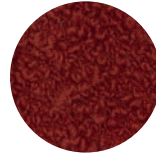

Bordeaux

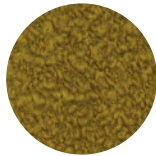

Senape  
Mustard

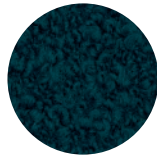

Petrolio  
Blue-Green

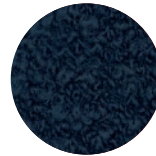

Blu Notte  
Night Blue

### Maharam Merit

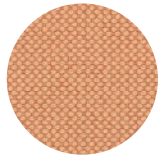

Salmone  
Salmon

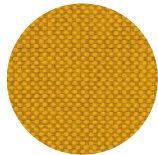

Ciallo  
Yellow

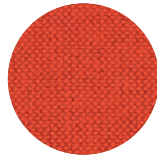

Rosso Corallo  
Coral Red

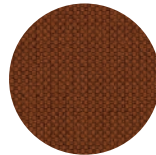

Marrone  
Brown

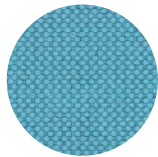

Celeste  
Sky Blue

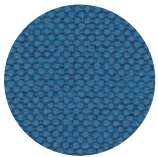

Blu Cobalto  
Cobalt Blue

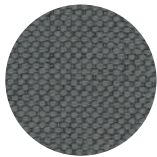

Grigio  
Grey

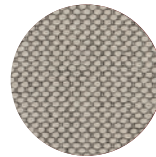

Sale e Pepe  
Salt and Pepper

TESSUTI | FABRICS

D

Rohi Sera

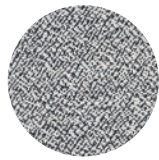

Pepper

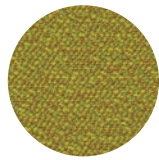

Tivoli

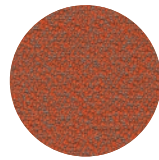

Glow

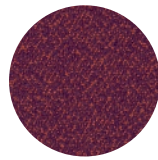

Berry

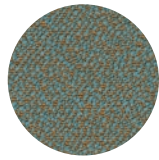

Mirage

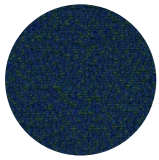

Mare

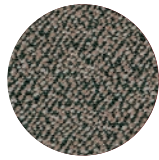

Walnut



Rosewood

Rohi Mica

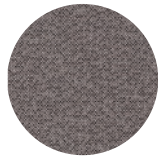

Pepper

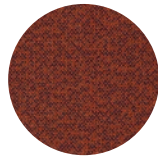

Indio

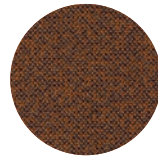

Amber

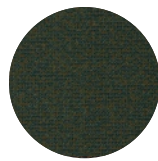

Jungle

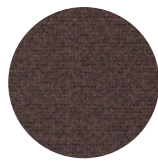

Mud

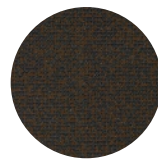

Secret

# FINITURE | FINISHES

## TESSUTI | FABRICS

E

### Kvadrat Steelcut Trio 3

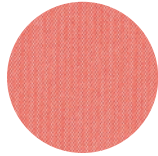

Arancia Rossa  
Red Orange



Pavone  
Peacock

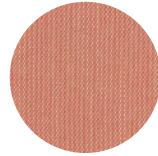

Pesca  
Peach



Sale e Pepe  
Salt and Pepper



Elettricità  
Electricity