

CLARETTA BOLD

by Florian Schmid

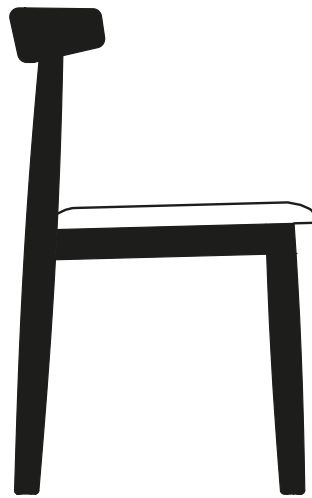

Claretta è diventata adulta e ha preso inevitabilmente qualche chilo. Niente di preoccupante, non fate quella faccia strana se si chiama Bold. È grossa, formosa e a noi piace così. L'espressione esile degli anni passati, che faceva tenerezza, è diventata scultorea e decisa. Ha la voce alta, da protagonista e forse è un po' egocentrica. Noi però preferiamo definirla carismatica. Si veste anche con due nuovi tessuti, il velluto per le situazioni eleganti e lo "sponge" quando vuole distinguersi dalle altre. Si inserisce perfettamente nei tavoli ed è impilabile.

Claretta is all grown-up, and has inevitably gained a few kilos. Nothing to worry about, don't pull that face if we call it Bold. It is big, voluptuous, and we like it that way. The slender expression of past years, which we viewed with tenderness, has now grown more sculptural and decisive. It has the loud voice of a protagonist, and is perhaps even a little self-centred. But we prefer to call it charismatic. It is dressed in new fabrics: velvet for elegant situations and "sponge" when it wants to stand out from the crowd. It fits beautifully with the tables, and is stackable.

DIMENSIONI | DIMENSIONS

lunghezza | width: 58 cm

larghezza | depth: 50 cm

altezza | height: 80 cm

altezza del sedile | seat height 48,4 cm

impilabilità | stackability: sì (X3) | yes (X3)

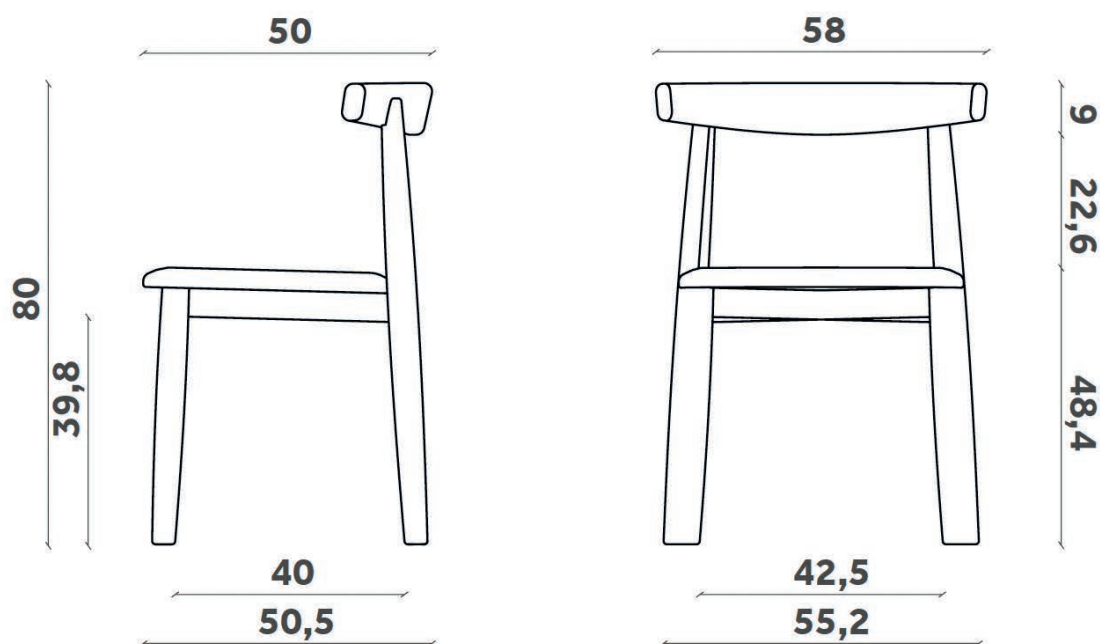

AMBIENTE | ENVIRONMENT

interno | indoor

DOWNLOAD | DOWNLOADS

la guida Cura e Manutenzione è disponibile su miniforms.com
Care and Maintenance guide is available at miniforms.com

file 2D, 3D e fotografie sono disponibili su miniforms.com
2D, 3D files and hi-res images are available at miniforms.com

FINITURE | FINISHES

LEGNO | WOOD

Struttura | Structure



Frassino
Ash



Frassino Tinto Rovere
Ash Stained Oak



Frassino Tinto Noce
Ash Stained Walnut



Frassino Nero
Black Ash

FINITURE | FINISHES

TESSUTI | FABRICS

A

Fluxo Bloom Ecoleather



Avorio
Ivory



Bianco
White

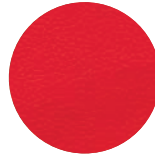

Rosso
Red

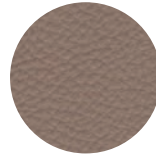

Tortora
Dove Grey



Testa di Moro
Dark Brown

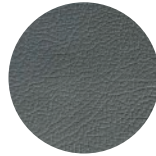

Grigio Scuro
Dark Grey

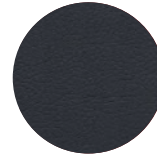

Nero
Black

Tramè



Beige

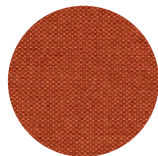

Arancio
Orange

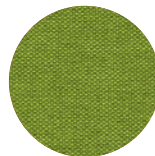

Mela
Apple

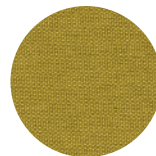

Senape
Mustard

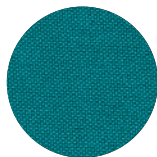

Pavone
Peacock

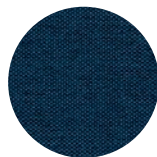

Blu Elettrico
Electric Blue



Nero
Black

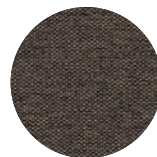

Grigio Scuro
Dark Grey

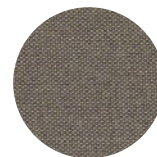

Tortora
Dove Grey

Madrid

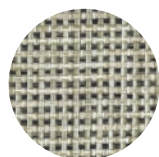

Burro
Butter

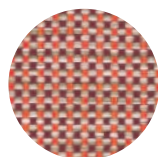

Melograno
Pomegranate

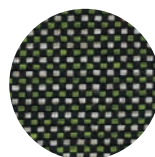

Menta
Mint

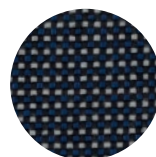

Notte
Night

TESSUTI | FABRICS

A

Salò

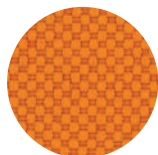

Arancio
Orange

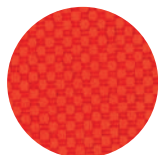

Rosso
Red



Marmellata
Jam

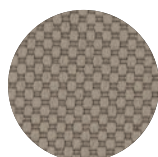

Grigio Chiaro
Light Grey



Marrone
Brown



Blu Notte
Midnight Blue

Loop

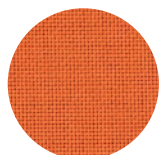

Arancione
Orange

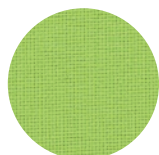

Lime

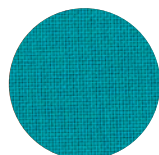

Turchese
Turquoise

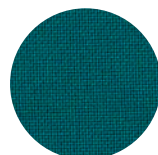

Ottanio
Teal Green

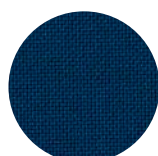

Blu Scuro
Dark Blue



Testa di Moro
Dark Brown

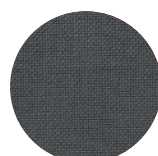

Grigio Fumo
Smoke Grey



Nero
Black

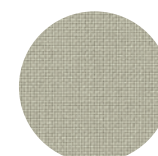

Avorio
Ivory

FINITURE | FINISHES

TESSUTI | FABRICS

B

Fluxo Rebel Econabuk



Seppia
Sepia



Nocciola
Light Brown

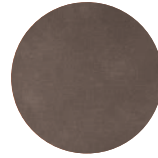

Marrone
Brown



Grigio
Grey

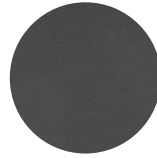

Antracite
Anthracite

Fluxo Platinum

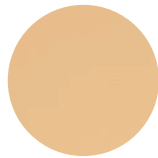

Pesca
Peach

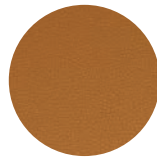

Nocciola
Hazelnut

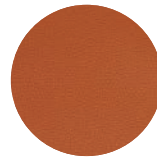

Mattone
Brick

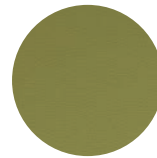

Verde
Green

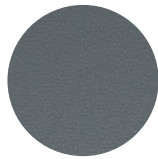

Nuvoloso
Cloudy

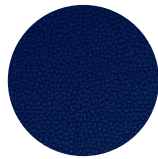

Blu
Blue



Porpora
Purple

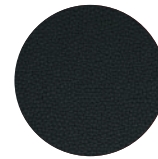

Nero
Black

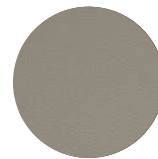

Tortora
Dove Grey

Mesh

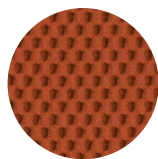

Rosso Corallo
Coral Red

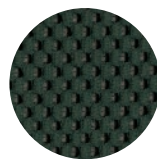

Verde Salvia
Sage Green

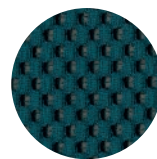

Foglia di Tè
Teal

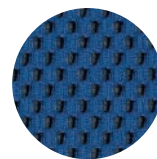

Blu Neon
Neon Blue

TESSUTI | FABRICS

B

Kvadrat Relate



Rosa
Pink

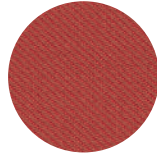

Rosso
Red

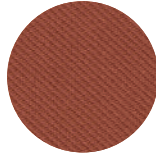

Terra
Ground

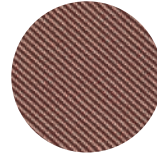

Snack

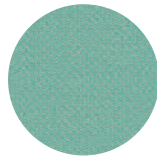

Menta
Mint

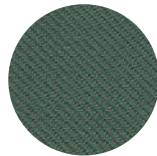

Verde Bosco
Forest Green

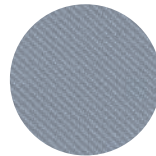

Nuvolo
Cloudy

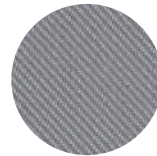

Crigio
Grey

Torrilana Cubbio

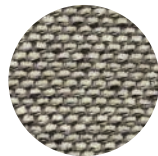

Sale e Pepe
Salt and Pepper

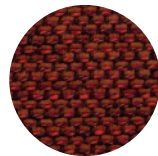

Ambra
Amber

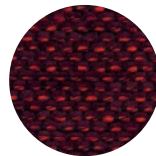

Bordeaux

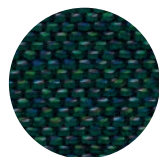

Verde Petrolio
Petrol Green

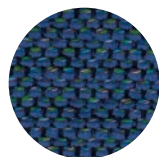

Blu Elettrico
Electric Blue



Castagna
Walnut

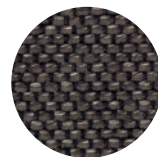

Tortora
Dove Grey

Lanee



Crigio
Grey

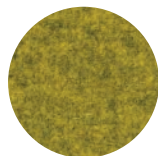

Giallo
Yellow

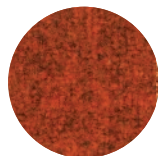

Rosso
Red

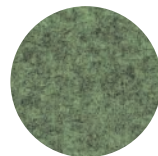

Menta
Mint

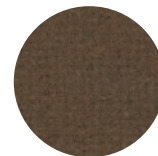

Marrone
Brown

FINITURE | FINISHES

TESSUTI | FABRICS

C

Shelter Velvet



Crema
Cream



Rosa Intenso
Intense Rose



Terra di Siena
Burnt Sienna



Cammello
Camel



Verde
Green

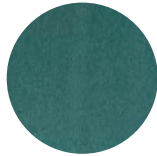

Turchese
Turquoise



Blu Notte
Midnight Blue



Testa di Moro
Dark Brown

Kvadrat Field 2

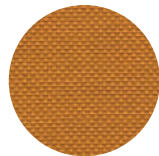

Zafferano
Saffron-Yellow

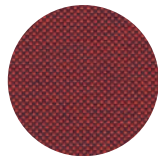

Ciliegia
Cherry

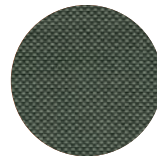

Menta
Mint

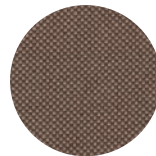

Nocciola
Hazel

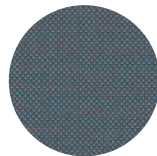

Zucchero
Sugar

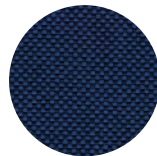

Blu
Blue

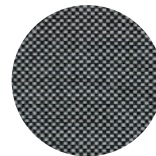

Sale e Pepe
Salt and Pepper

Torrilana Brionne



Black and White

TESSUTI | FABRICS

C

Vescom Harding

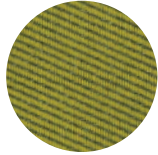

Ciallo
Yellow

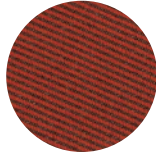

Rosso
Red

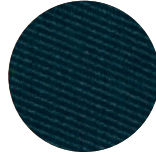

Petrolio
Blue-Green

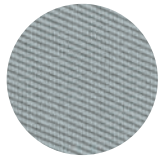

Grigio Chiaro
Light Grey

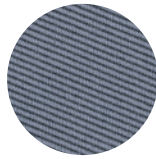

Nuvolo
Cloudy

Vescom Rolla

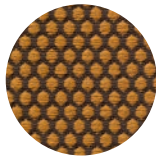

Mostarda
Mustard

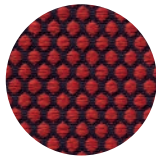

Ciliegia
Cherry

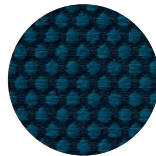

Blu Pavone
Peacock

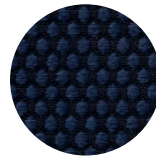

Blu Notte
Midnight Blue

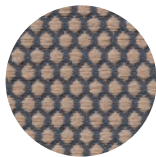

Latte
Steamed Milk

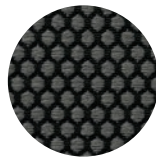

Antracite
Anthracite

Torilana Rakam



Bacca
Berry

FINITURE | FINISHES

TESSUTI | FABRICS

D

Cloud



Panna
Cream



Noce
Walnut

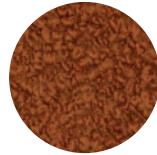

Nocciola
Hazelnut

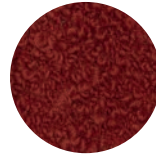

Bordeaux

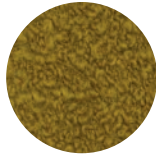

Senape
Mustard

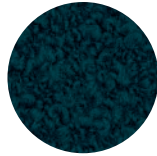

Petrolio
Blue-Green

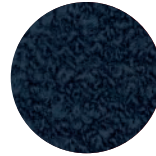

Blu Notte
Night Blue

Maharam Merit

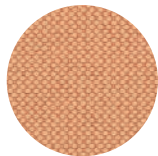

Salmone
Salmon

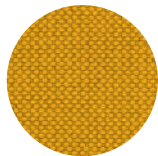

Ciallo
Yellow

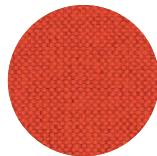

Rosso Corallo
Coral Red



Marrone
Brown

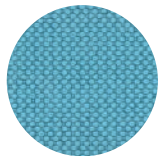

Celeste
Sky Blue

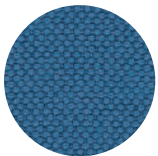

Blu Cobalto
Cobalt Blue

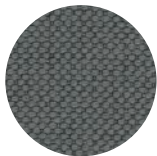

Grigio
Grey

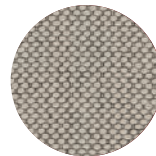

Sale e Pepe
Salt and Pepper

TESSUTI | FABRICS

D

Rohi Sera

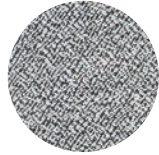

Pepper

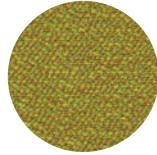

Tivoli

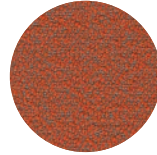

Clow

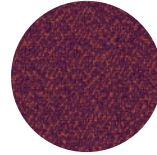

Berry

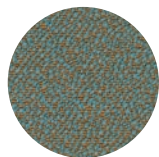

Mirage

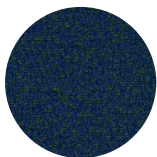

Mare

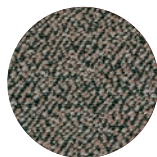

Walnut



Rosewood

Rohi Mica

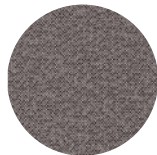

Pepper

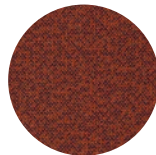

Indio

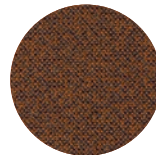

Amber

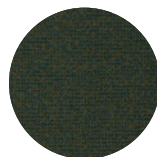

Jungle

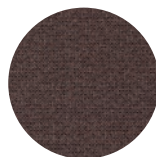

Mud

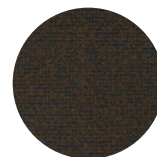

Secret

FINITURE | FINISHES

TESSUTI | FABRICS

E

Kvadrat Steelcut Trio 3

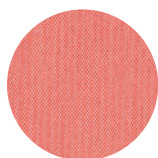

Arancia Rossa
Red Orange



Pavone
Peacock



Pesca
Peach



Sale e Pepe
Salt and Pepper



Elettricità
Electricity