

ARMADIO battente

nidi

hinged WARDROBE

ARMADI BATTENTI A CONTENITORE / HINGED DOOR WARDROBES SYSTEM

con frontale in battuta sui fianchi \ with partial overlay fronts
ripiani interni sp. 3 \ internal shelves 3cm thickness

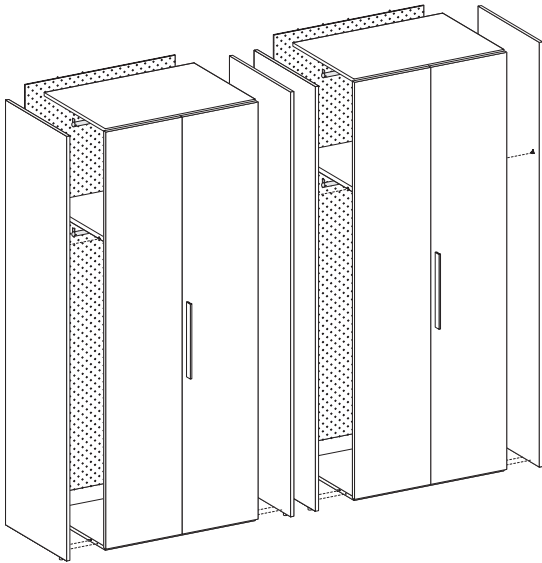

DIMENSIONI GENERALI / GENERAL DIMENSIONS

ARMADI BATTENTI A CONTENITORE / HINGED DOOR WARDROBE SYSTEMS

Altezze / Heights

Comprehensive di piedini regolabili altezza 0,7 cm
/ Heights include 0,7 cm-high adjustable feet

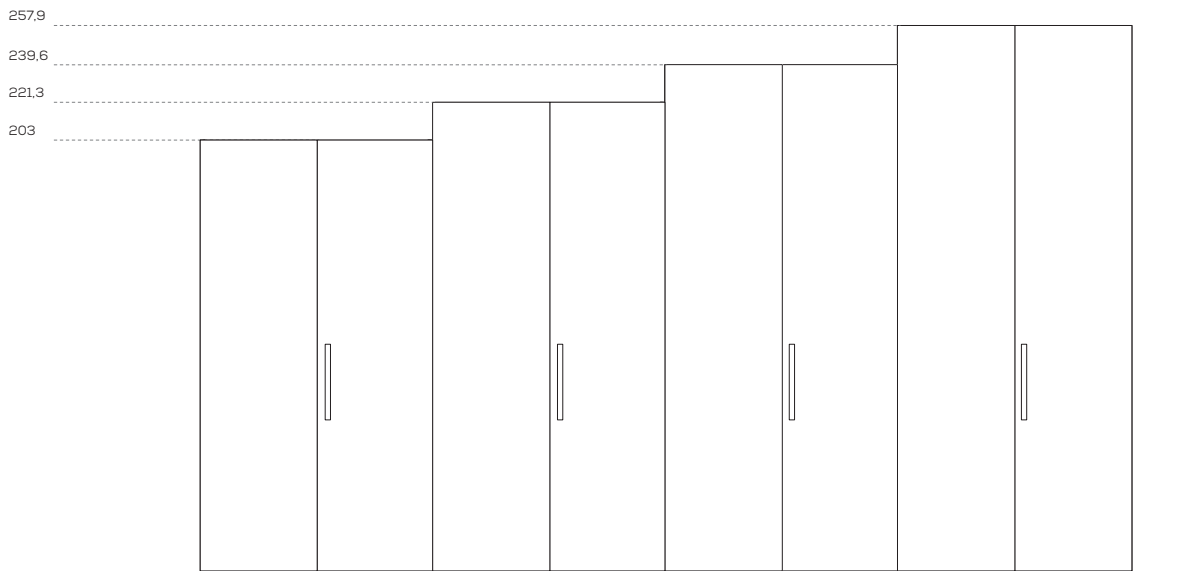

Larghezze / Widths

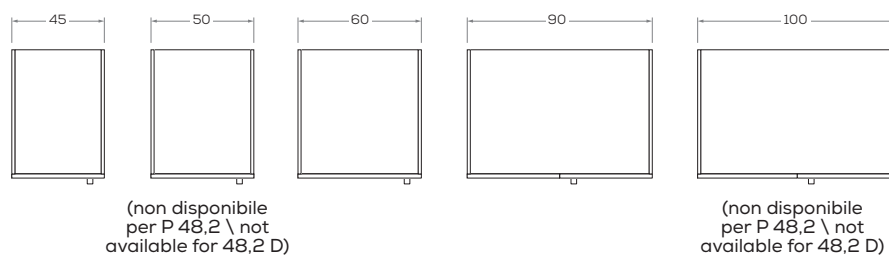

Profondità / Depths

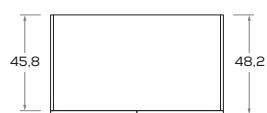

(non disponibile per L 50 e 100 \ not available for 50 and 100 W)

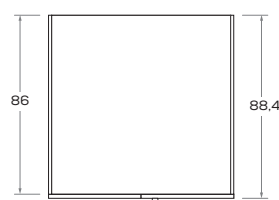
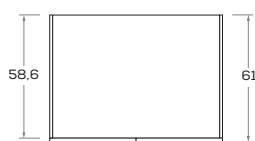

(non disponibile per H 203 \ not available for 203 H)

Angoli spogliatoio per armadi battenti a contenitore/ Walk-in closets for hinged doors wardrobe system

Angolo / Corner

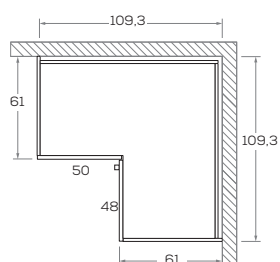

Angolo spogliatoio "S" / Walk-in closet "S"

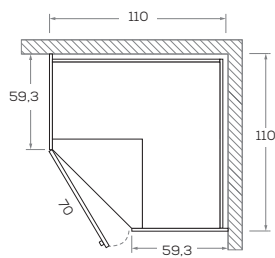

Angolo spogliatoio "M1" / Walk-in closet "M1"

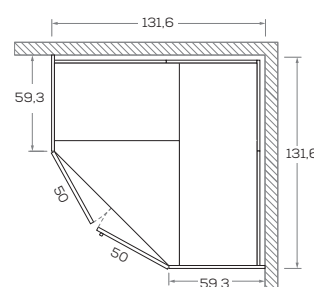

Angolo spogliatoio "M2" / Walk-in closet "M2"

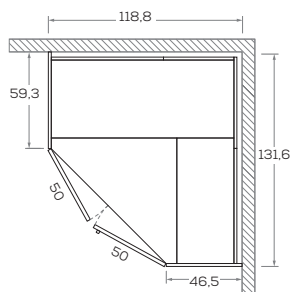

Angolo spogliatoio "M3" / Walk-in closet "M3"

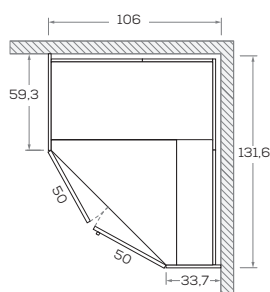

Angolo spogliatoio "L" / Walk-in closet "L"

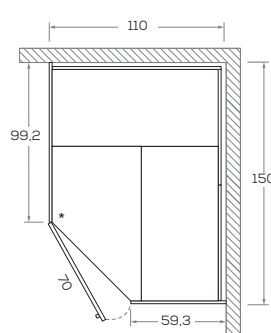

Terminali / End units

TRAP a giorno

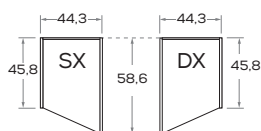

TRAP

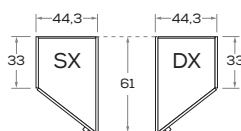

KAM

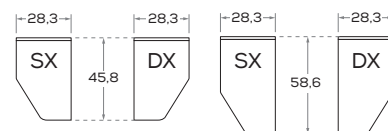

KAM+

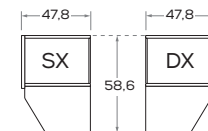

BAND

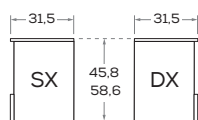

DEN

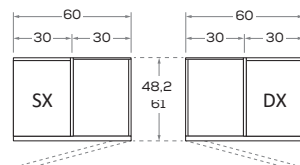

LUCE

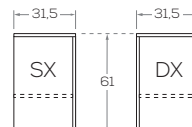

LOOP

Non riducibile / Cannot be cut to size.

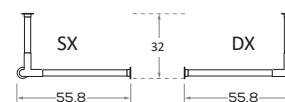

ARMADI BATTENTI A SPALLA / HINGED DOOR WARDROBE SYSTEMS WITH LOAD-BEARING SIDE PANELS

con frontale in battuta sui fianchi \ with partial overlay fronts
 ripiani interni sp. 3 \ internal shelves 3cm thickness

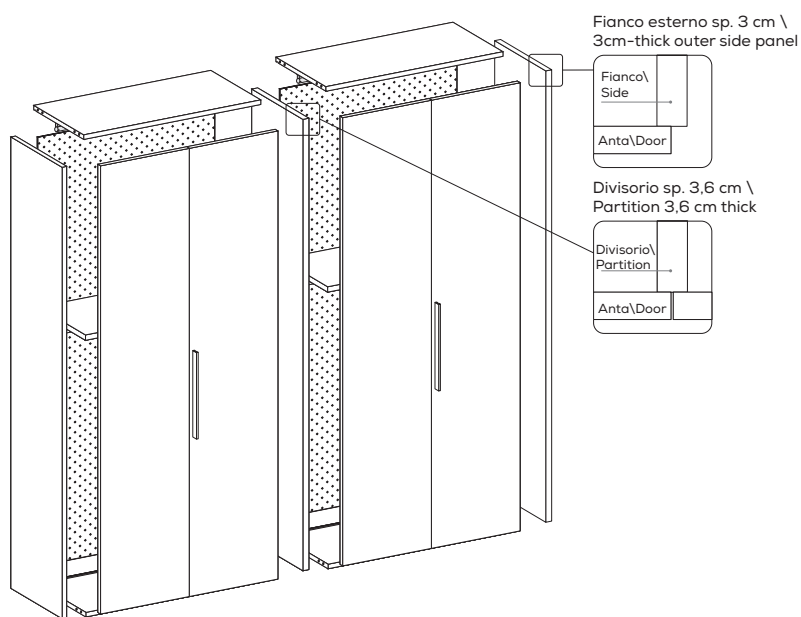

DIMENSIONI GENERALI / GENERAL DIMENSIONS

ARMADI BATTENTI A SPALLA / HINGED DOOR WARDROBE SYSTEMS WITH LOAD-BEARING SIDE PANELS

Altezze / Heights

Comprehensive di piedini regolabili altezza 0,7 cm
 / Heights include 0,7 cm-high adjustable feet

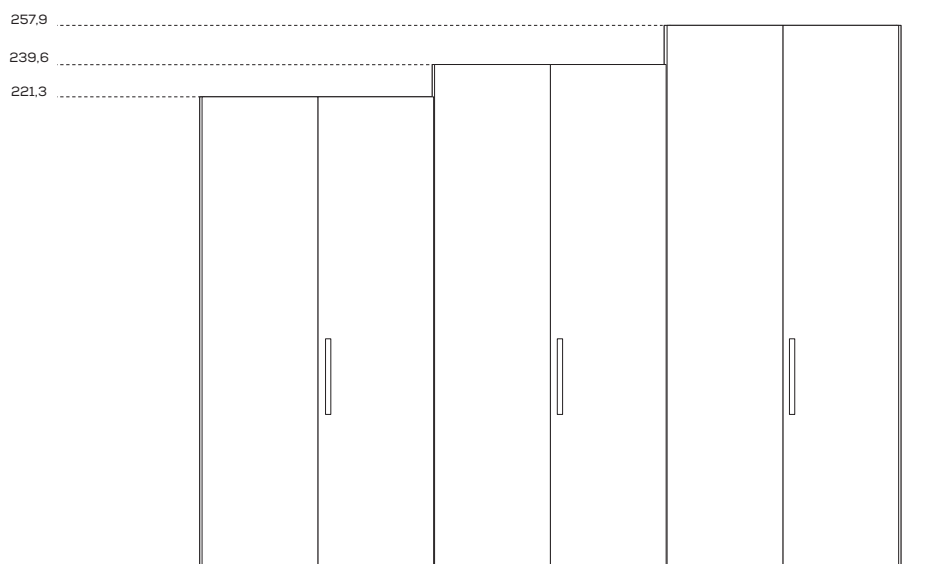

Larghezze / Widths

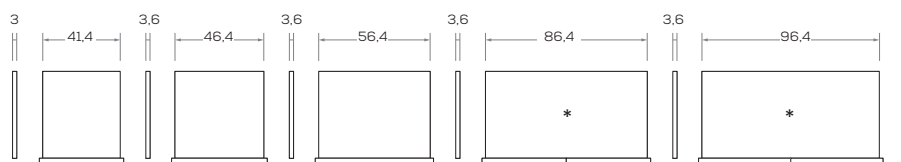

•Anta sinistra sempre con parapolvere \ Left door always has dust seal

Profondità / Depths

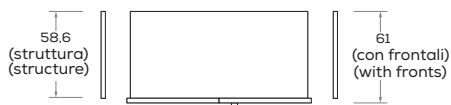

Angoli spogliatoio per armadi battenti a spalla / Walk-in closets for hinged doors wardrobe system with load-bearing side panels

Angolo / Corner

Angolo spogliatoio "M1-a"
/ Walk-in closet "M1-a"

Angolo spogliatoio "M1-b"
/ Walk-in closet "M1-b"

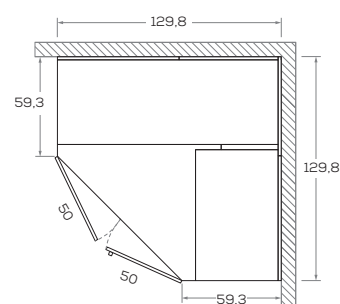
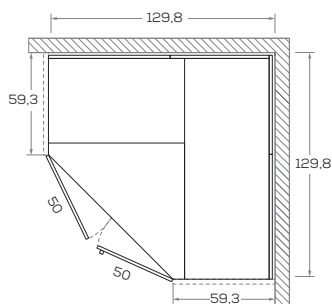
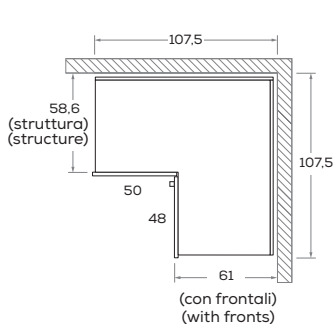

Angolo spogliatoio "M2-a"
/ Walk-in closet "M2-a"

Angolo spogliatoio "M2-b"
/ Walk-in closet "M2-b"

Angolo spogliatoio "M3"
/ Walk-in closet "M3"

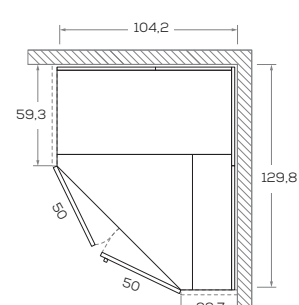
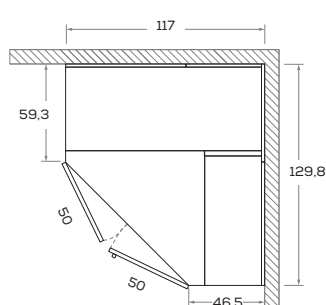
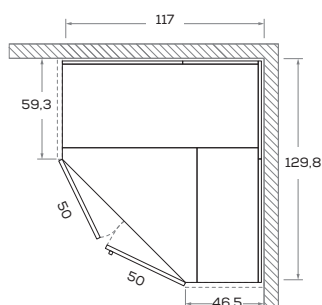

Terminali / End units

TRAP

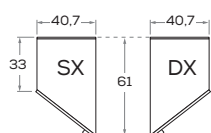

KAM

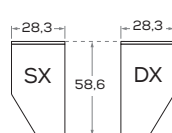

KAM+

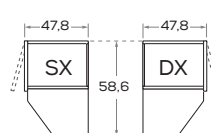

BAND

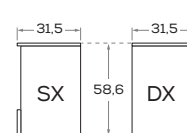

DEN

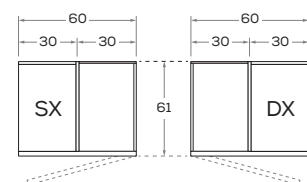

LUCE

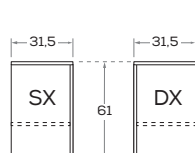

LOOP

Non riducibile /
Cannot be cut to size.

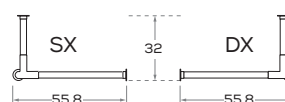

Tipologia ante / door type

per armadi battenti a contenitore e a spalla \

for hinged door wardrobes and hinged door wardrobe systems with load-bearing side panels

ANTA NIT / NIT DOOR

maniglie: tutti i modelli \
handles: all models

ANTA GRAPHIC / GRAPHIC DOOR

maniglie: tutti i modelli \
handles: all models

ANTA BEN / BEN DOOR

maniglie: BEN \
handles: BEN

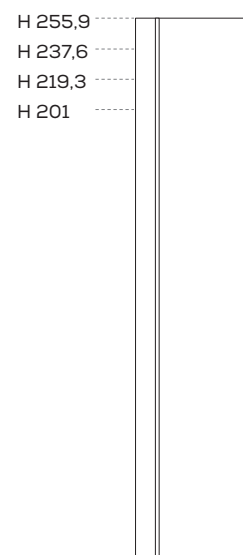
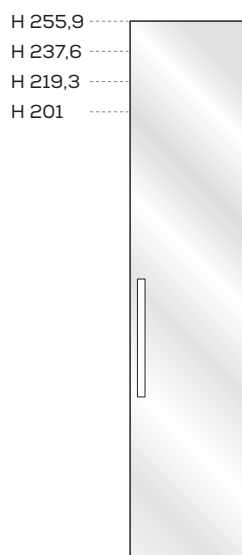
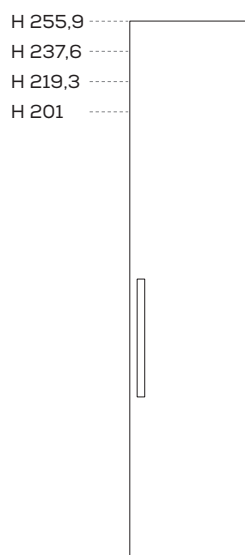

Dimensioni / Dimensions

L /W 44,7 - 49,7 - 59,7

Dimensioni / Dimensions

L /W 44,7 - 49,7 - 59,7

Dimensioni / Dimensions

L /W 44,7 - 49,7 - 59,7

ARMADIO LIGHT / LIGHT WARDROBE

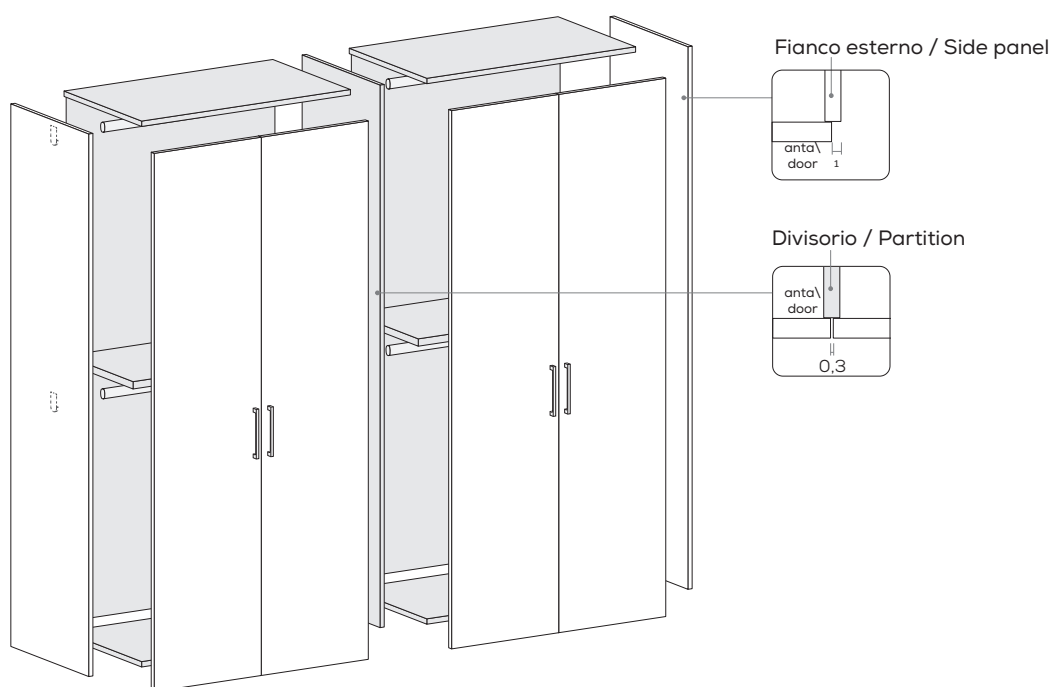

Dimensioni / Dimensions

L / W 44,4

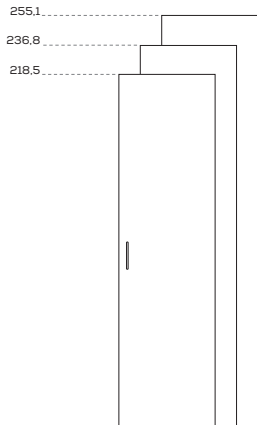

Maniglia \ handle KUBÒ L

Dimensione \ Dimension
L\W x H x P\D
26,8 x 3 x 2



DIMENSIONI GENERALI / GENERAL DIMENSIONS

Altezze / Heights

Comprehensive di piedini regolabili altezza 1,8 cm
/ Heights include 1,8cm-high adjustable feet

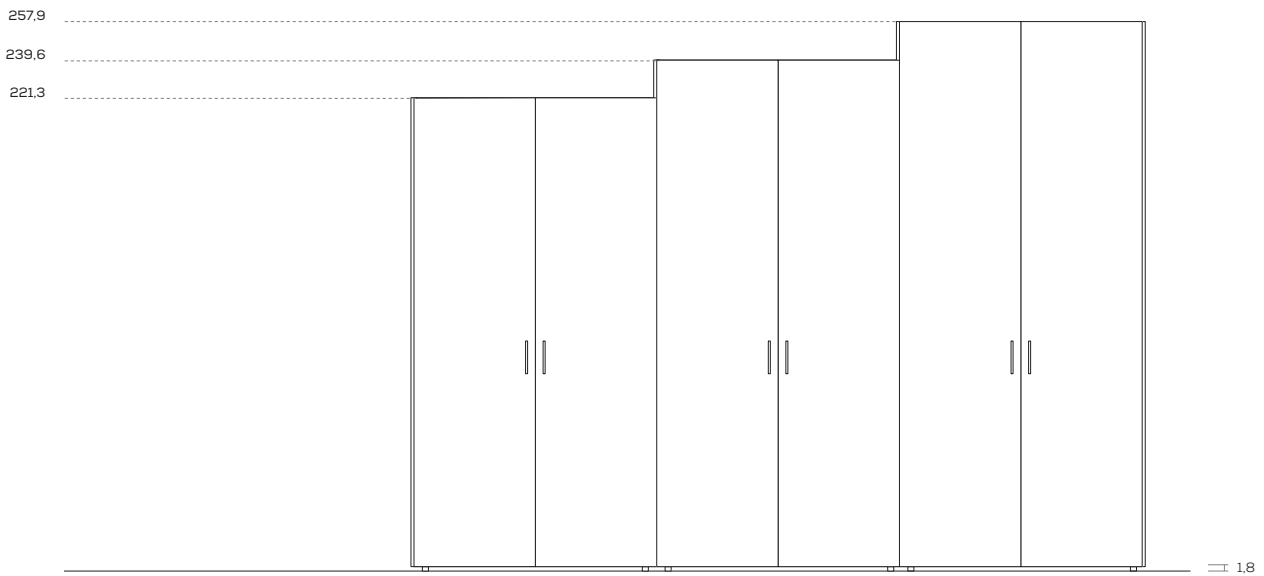

Larghezze / Widths



Profondità / Depth



esempio di accessori interni per armadi battenti (esclusi armadi Light) / example of internal fittings for hinged door wardrobe (light wardrobe excluded).

