

# Armadi scorrevoli

## Sliding door wardrobes

Ripiani interni sp. 3 cm.  
Internal shelves 3cm thickness.

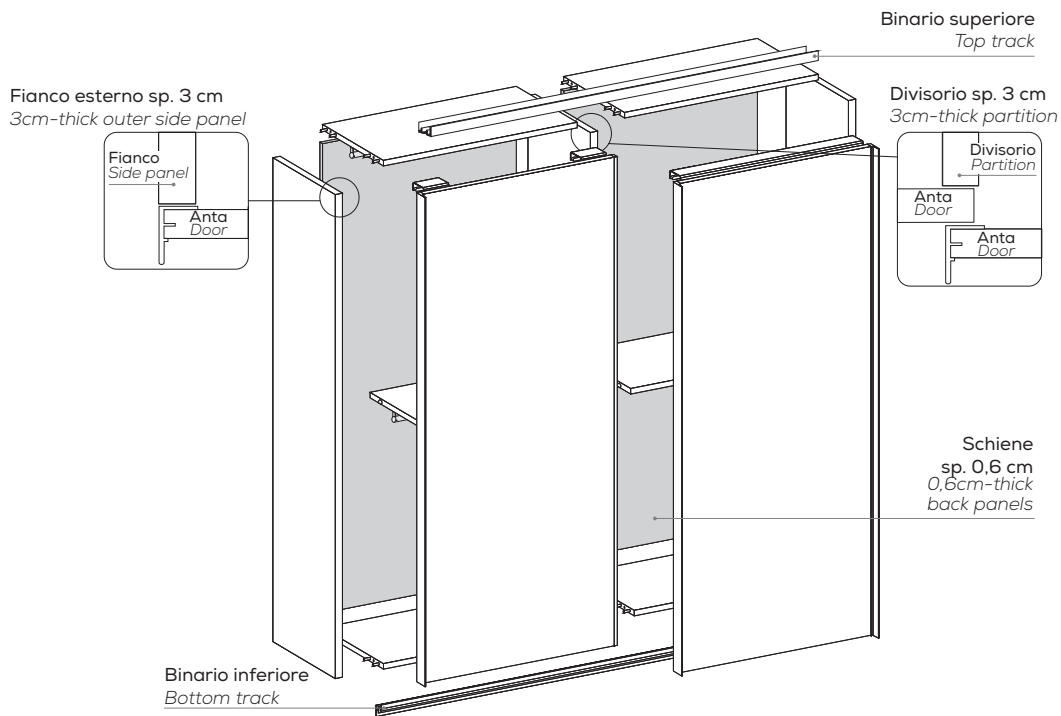

### ALTEZZE

#### HEIGHTS

Comprensive di piedini regolabili H 0,7 cm.

Includes 0,7 cm/high adjustable foot.

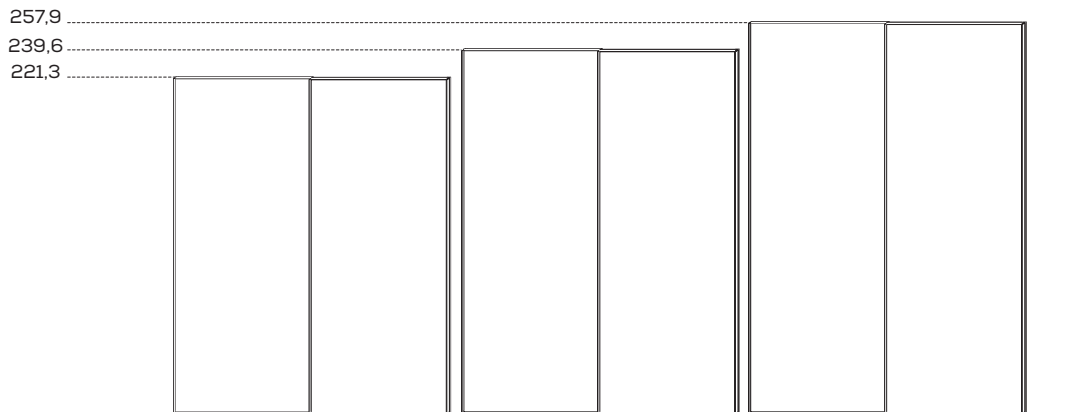

### LARGHEZZE

#### WIDTHS

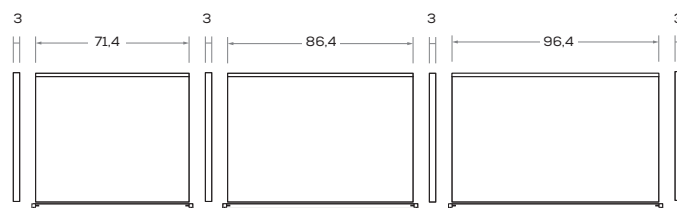

# Armadi scorrevoli

## Sliding door wardrobes

nidi

### PROFONDITÀ CON ANTE NIT sp. 2,2 cm

DEPTHS WITH NIT DOORS 2,2 cm thick

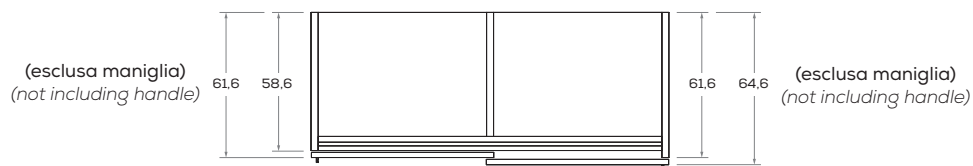

### PROFONDITÀ CON ANTE JACK

DEPTHS WITH JACK DOORS

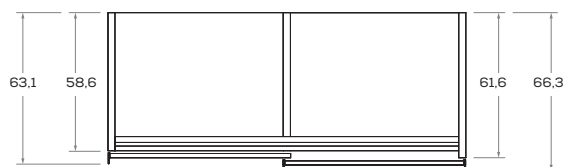

### PROFONDITÀ CON ANTE LILA sp. 2,8 cm

DEPTHS WITH LILA DOORS 2,8 cm thick

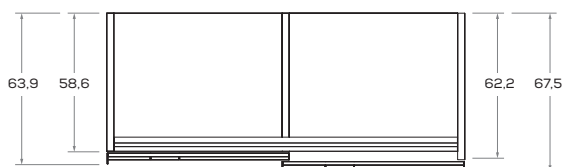

### VERSO D'APERTURA

DOOR OPENING DIRECTION

Il verso dell'armadio è dato dal verso d'apertura dell'anta esterna.

The wardrobe direction is determined by the direction of the outer door opens to left.

Armadio SX  
LH wardrobe

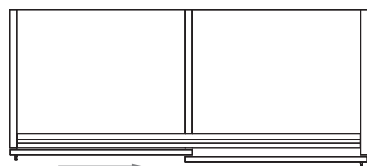

Armadio SX  
LH wardrobe

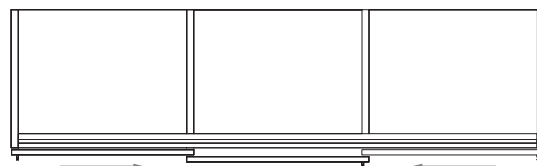

Le informazioni contenute nelle presenti schede tecniche sono indicative. Eventuali differenze con il listino in vigore non costituiscono motivo di contestazione.  
The information given in this technical sheet are indicative. Any discrepancies with the price list currently in force cannot be cause for complaint.

# Armadi scorrevoli

## Sliding door wardrobes

### TIPOLOGIA ANTE

DOOR TYPE

#### ANTA NIT

NIT DOOR

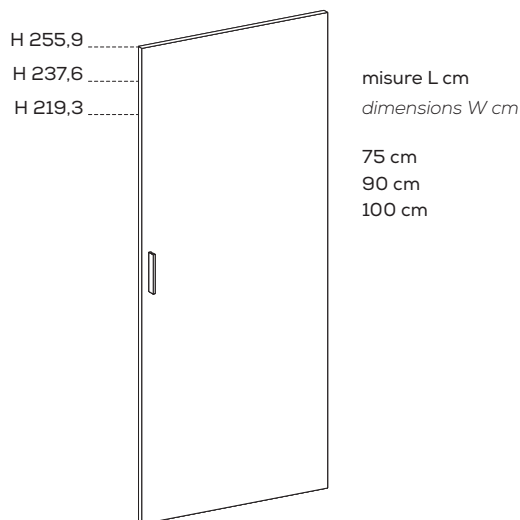

#### ANTA JACK

JACK DOOR



#### ANTA LILA

LILA DOOR

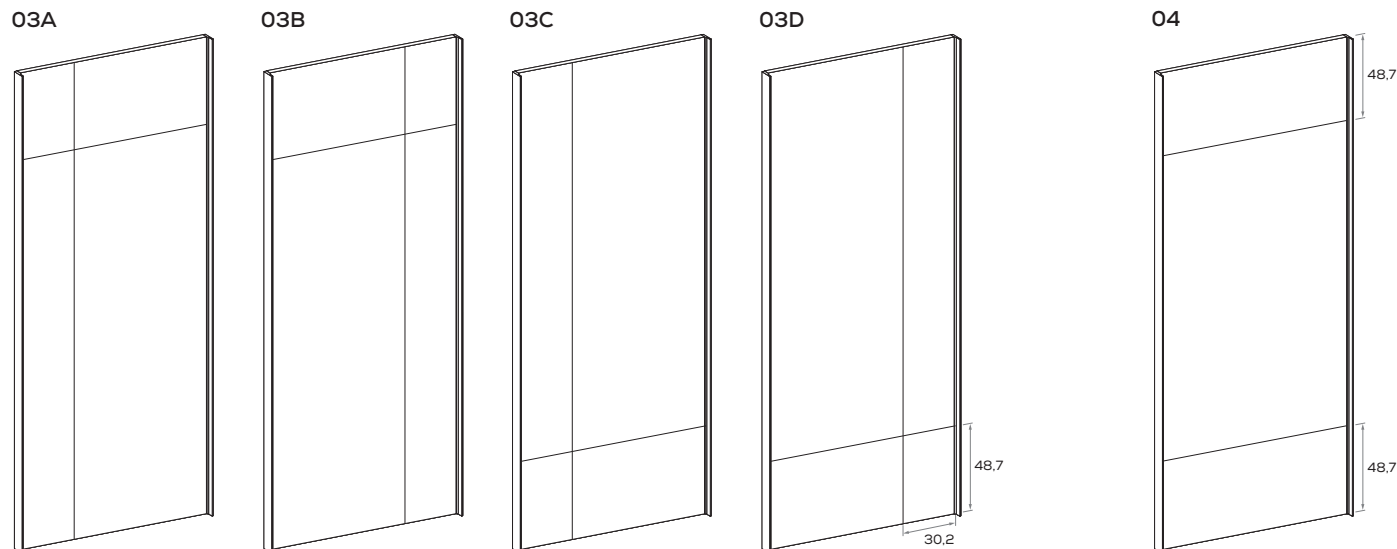
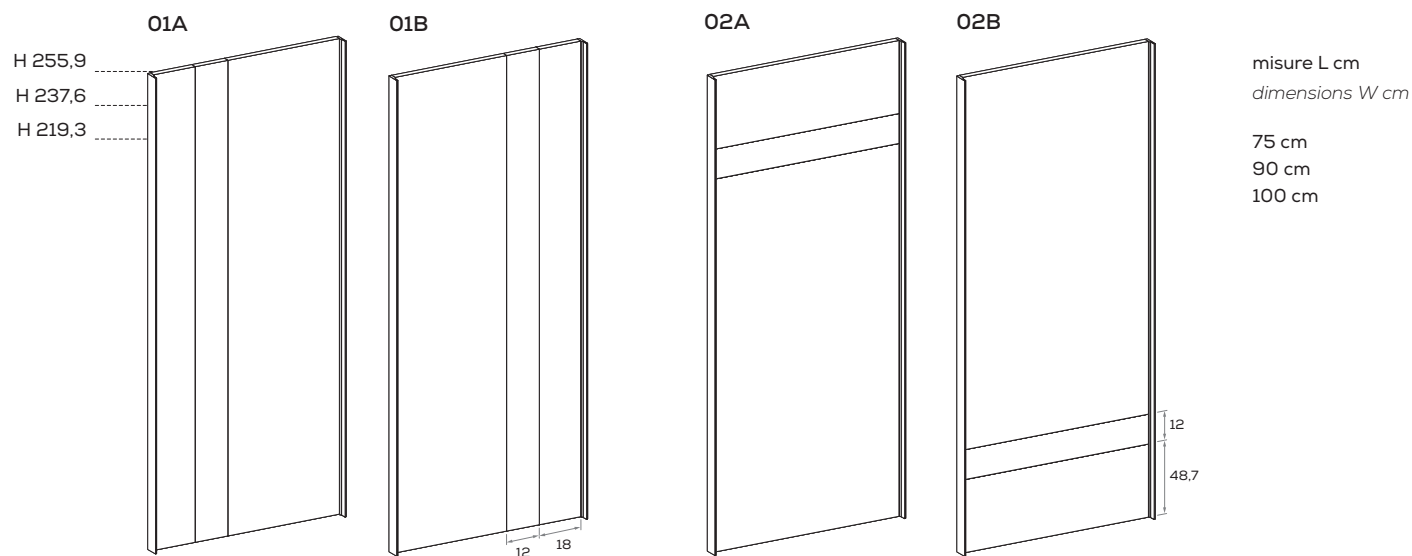

Le informazioni contenute nelle presenti schede tecniche sono indicative. Eventuali differenze con il listino in vigore non costituiscono motivo di contestazione.  
The information given in this technical sheet are indicative. Any discrepancies with the price list currently in force cannot be cause for complaint.