

# Ponti battenti ad angolo

Corner hinged door bridging units

---

## PONTE AD ANGOLO

CORNER BRIDGING UNIT

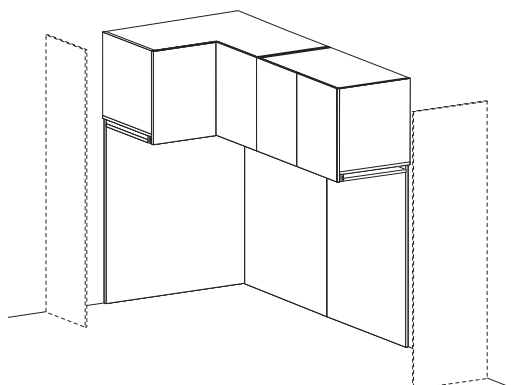

# Ponti battenti ad angolo

## Corner hinged door bridging units

nidi

### LARGHEZZE E PROFONDITÀ

WIDTHS AND DEPTHS

L. cm **209,3**

W. cm

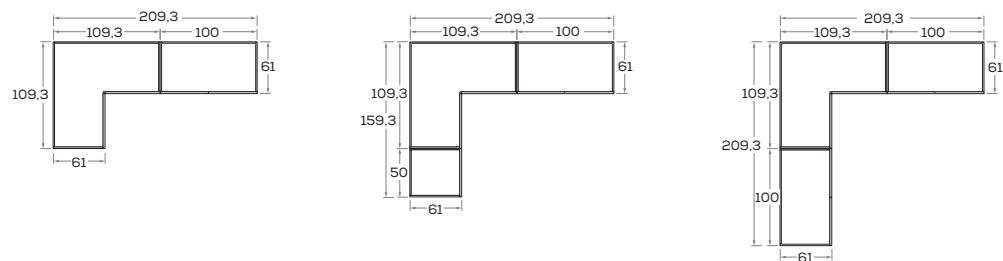

L. cm **229,3**

W. cm

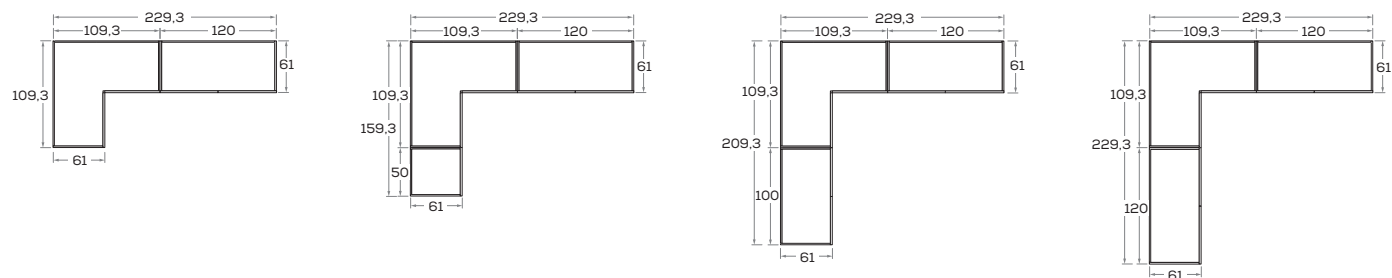

L. cm **259,3**

W. cm

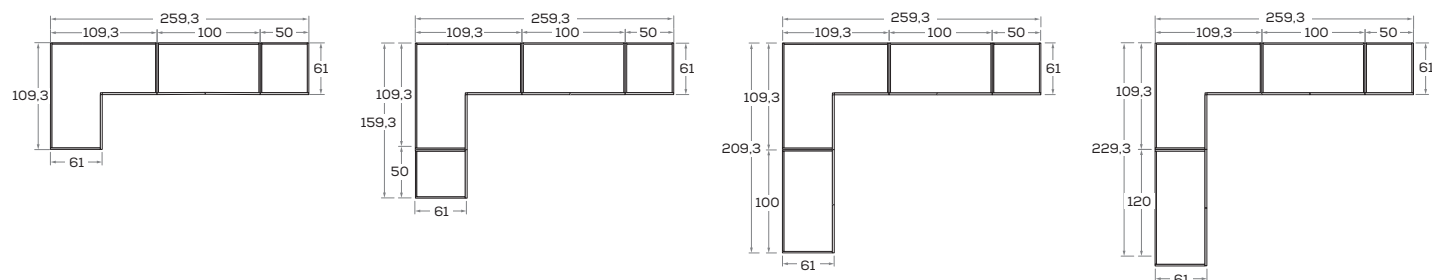

L. cm **289,3**

W. cm

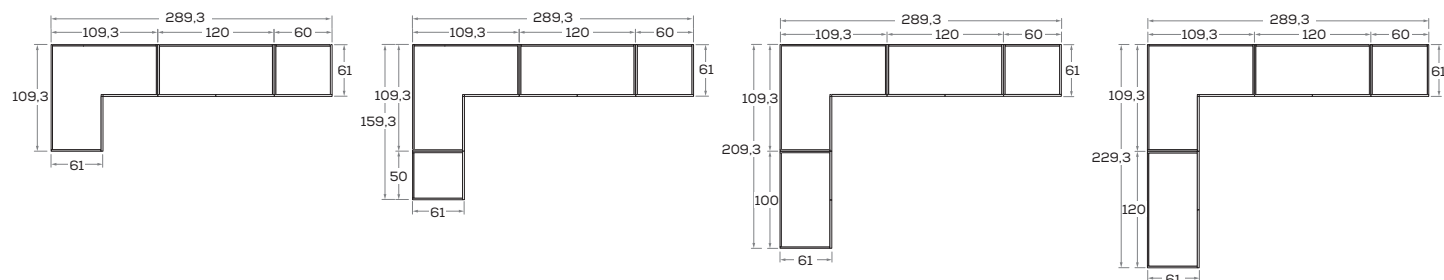

Le informazioni contenute nelle presenti schede tecniche sono indicative. Eventuali differenze con il listino in vigore non costituiscono motivo di contestazione.  
The information given in this technical sheet are indicative. Any discrepancies with the price list currently in force cannot be cause for complaint.

# Ponti battenti ad angolo con cambio profondità

## Corner hinged door bridging units with different depths

nidi

### LARGHEZZE E PROFONDITÀ

WIDTHS AND DEPTHS

L. cm **196,5**

W. cm

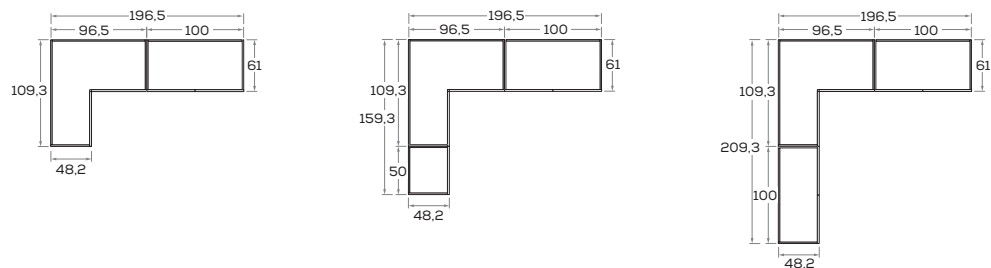

L. cm **216,5**

W. cm

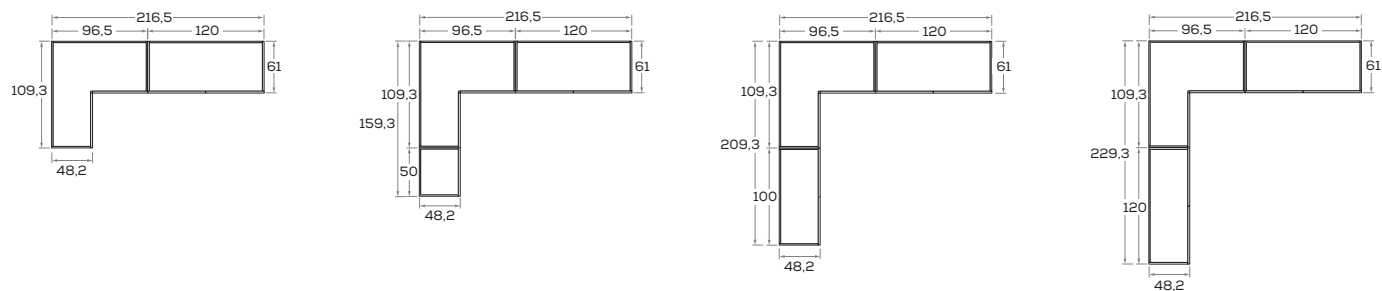

L. cm **246,5**

W. cm

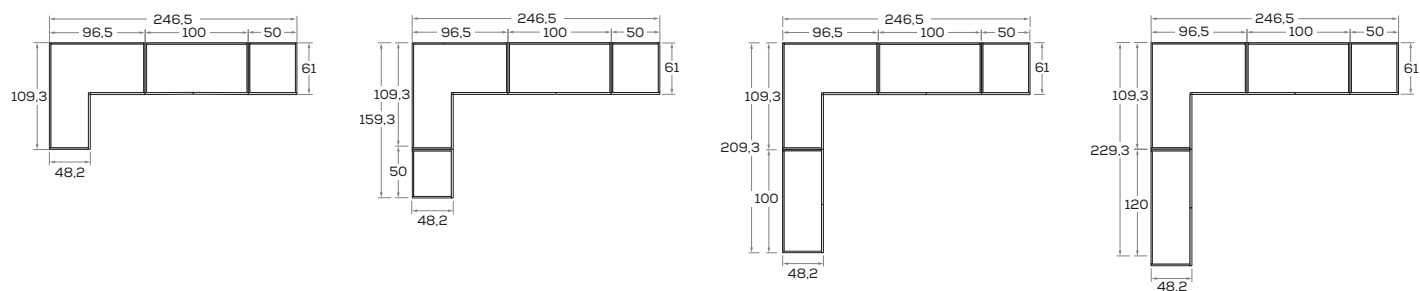

L. cm **276,5**

W. cm

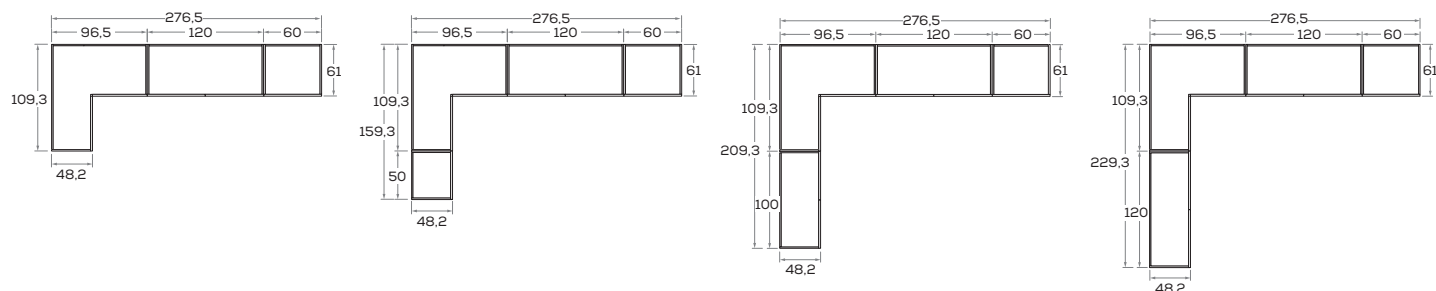

Le informazioni contenute nelle presenti schede tecniche sono indicative. Eventuali differenze con il listino in vigore non costituiscono motivo di contestazione.  
The information given in this technical sheet are indicative. Any discrepancies with the price list currently in force cannot be cause for complaint.

### FIANCHI SP. 3 CM

3CM-THICK SIDES

#### SCIÒ

laterale / centrale  
side / centre

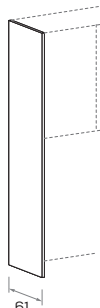

#### GINO

laterale / centrale  
side / centre

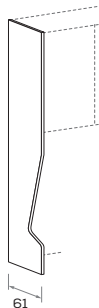

#### TIPPY

laterale  
side

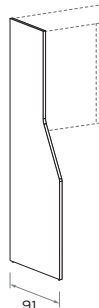

### FIANCHI METALLICI

METAL SIDE PANELS

#### ECCÌ

laterale / centrale  
side / centre

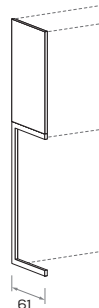

#### RACK

laterale / centrale  
side / centre

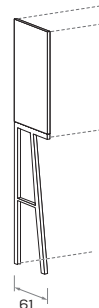

### FIANCHI SOSPESI

WALL-MOUNTED SIDE PANELS

#### APP

laterale  
side

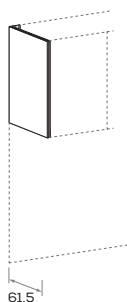

centrale  
centre

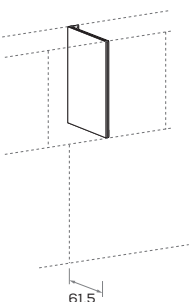

I ponti lineari con fianco APP prevedono sempre la barra posteriore.  
Straight bridging units with APP side panels always have the rear bar.

### ESEMPI DI COMPOSIZIONE

EXAMPLES OF CONFIGURATION

