

Ponti battenti ad angolo

Corner hinged door bridging units

PONTE AD ANGOLO

CORNER BRIDGING UNIT

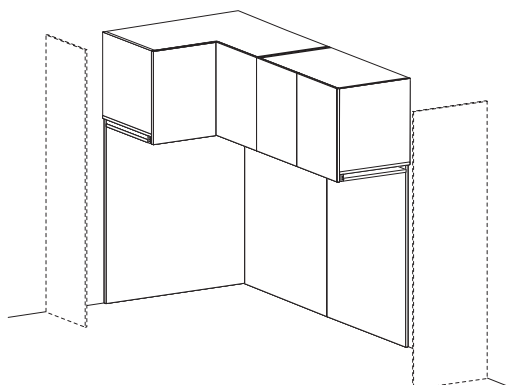

Ponti battenti ad angolo

Corner hinged door bridging units

nidi

LARGHEZZE E PROFONDITÀ

WIDTHS AND DEPTHS

L. cm **209,3**

W. cm

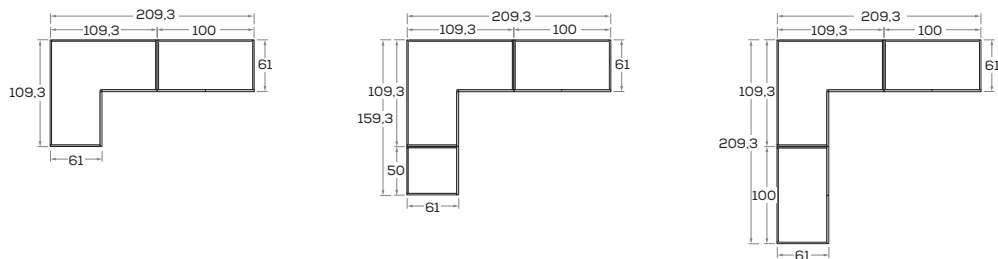

L. cm **229,3**

W. cm

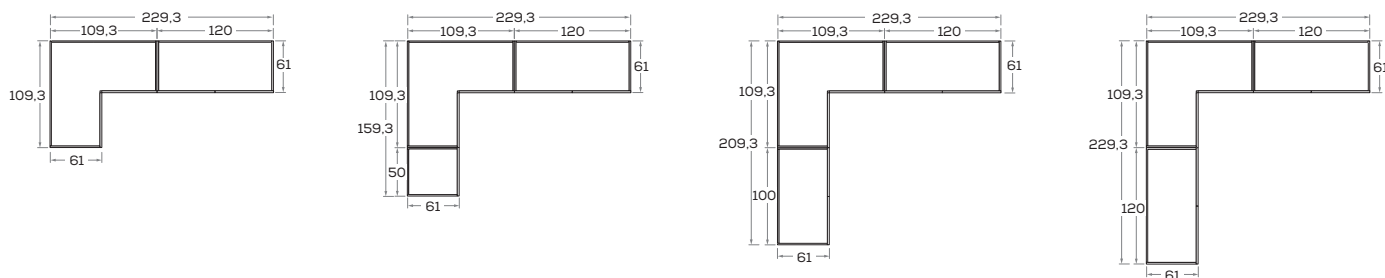

L. cm **259,3**

W. cm

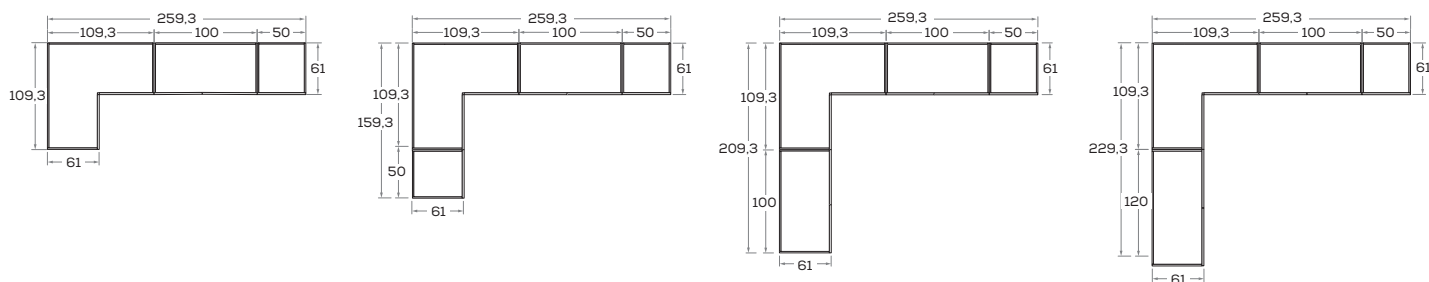

L. cm **289,3**

W. cm

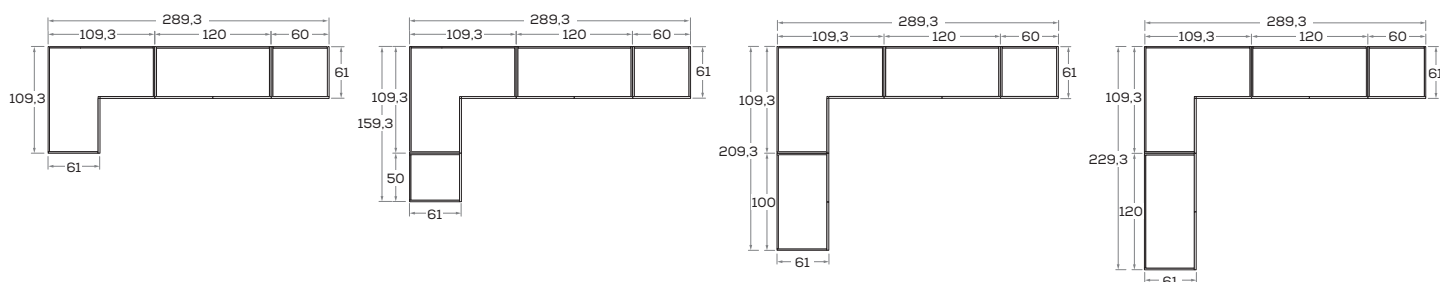

Le informazioni contenute nelle presenti schede tecniche sono indicative. Eventuali differenze con il listino in vigore non costituiscono motivo di contestazione.
The information given in this technical sheet are indicative. Any discrepancies with the price list currently in force cannot be cause for complaint.

Ponti battenti ad angolo con cambio profondità

Corner hinged door bridging units with different depths

nidi

LARGHEZZE E PROFONDITÀ

WIDTHS AND DEPTHS

L. cm **196,5**

W. cm

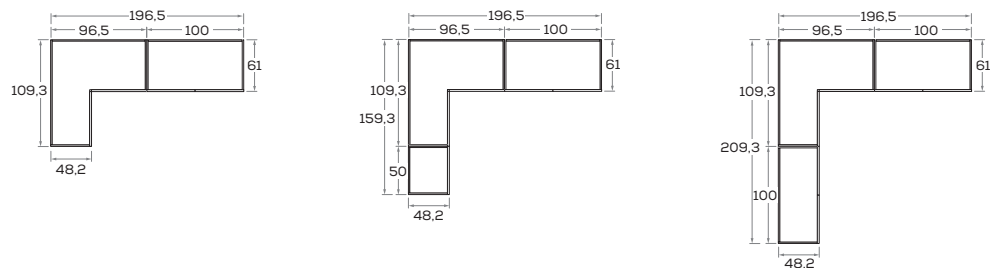

L. cm **216,5**

W. cm

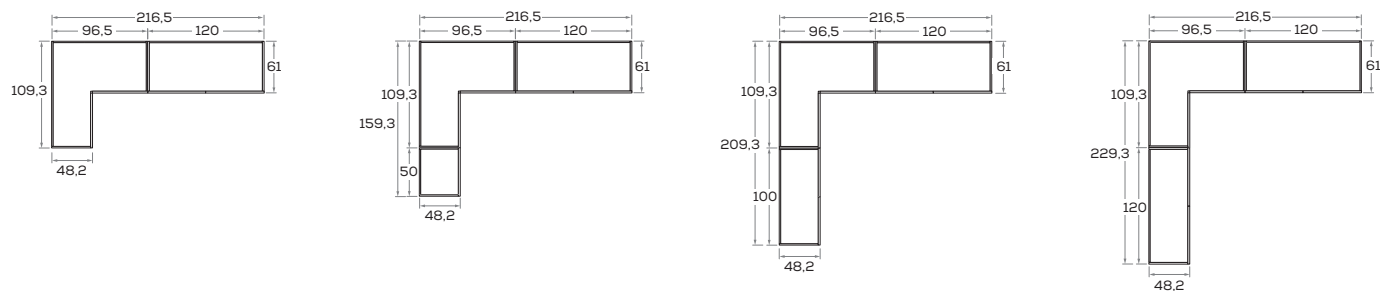

L. cm **246,5**

W. cm

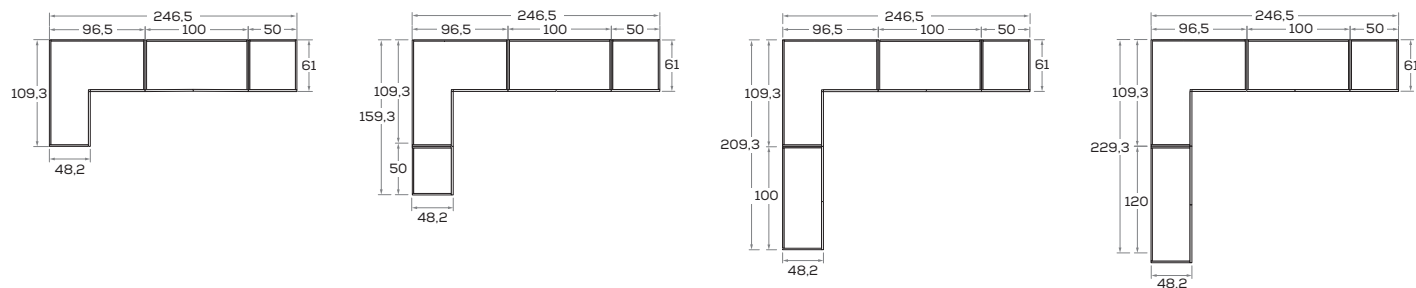

L. cm **276,5**

W. cm

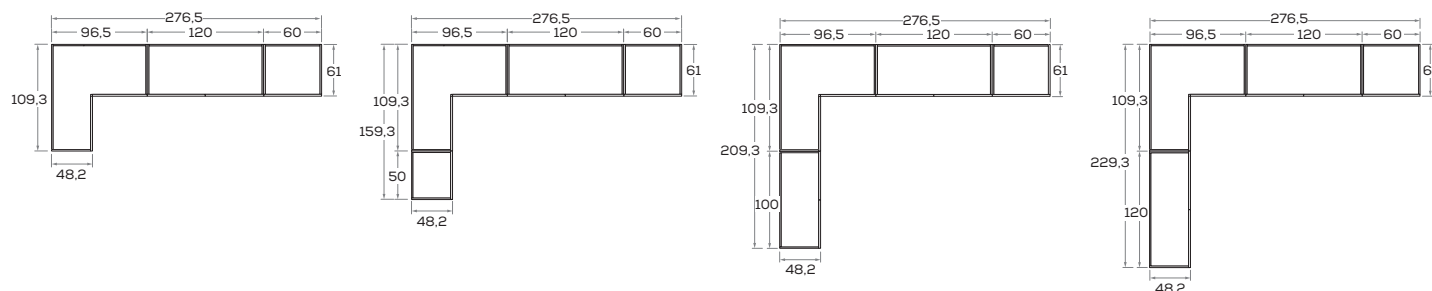

Le informazioni contenute nelle presenti schede tecniche sono indicative. Eventuali differenze con il listino in vigore non costituiscono motivo di contestazione.
The information given in this technical sheet are indicative. Any discrepancies with the price list currently in force cannot be cause for complaint.

FIANCHI SP. 3 CM

3CM-THICK SIDES

SCIÒ

laterale / centrale
side / centre

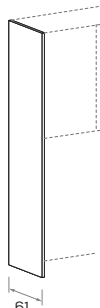

GINO

laterale / centrale
side / centre

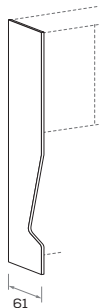

TIPPY

laterale
side

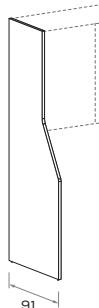

FIANCHI METALLICI

METAL SIDE PANELS

ECCÌ

laterale / centrale
side / centre

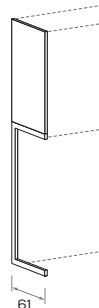

RACK

laterale / centrale
side / centre

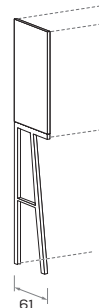

FIANCHI SOSPESI

WALL-MOUNTED SIDE PANELS

APP

laterale
side

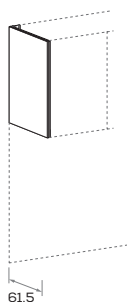

centrale
centre

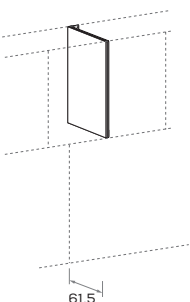

I ponti lineari con fianco APP prevedono sempre la barra posteriore.
Straight bridging units with APP side panels always have the rear bar.

ESEMPI DI COMPOSIZIONE

EXAMPLES OF CONFIGURATION

