

ZIGGY BED

Design C. Ballabio

LETTO | BED

2015



ZIGGY BED

Design C. Ballabio

LETTO | BED

2015

Letto smontabile con struttura in noce canaletta completa di rete a doghe in legno.

Dismountable bed with frame in solid canaletta walnut and wooden slatted bed base.

Demontiertes Bett mit Gestell aus massivem Nussbaum Canaletta mit Lattenrost aus Holz.

Lit avec structure démontée en noyer canaletta massif, avec lattes en bois.

Somier desmontable con duelas en nogal canaletta.

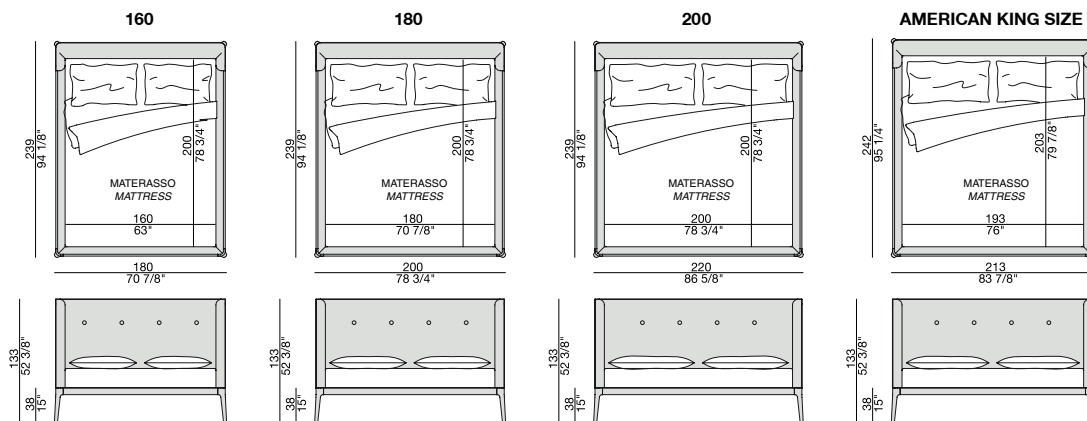

Essenze | Wood

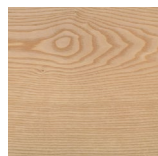

FRASSINO NATURALE
Natural Ash

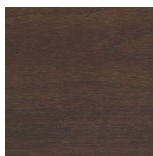

FRASSINO
Ash
tinto/stained moka

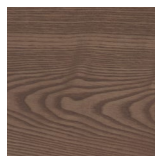

FRASSINO
Ash
tinto/stained canaletta walnut



FRASSINO
Ash
tinto/stained wengé

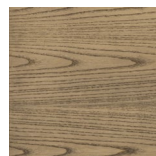

FRASSINO
Ash
tinto/stained canapa

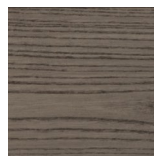

FRASSINO
Ash
tinto/stained caffè

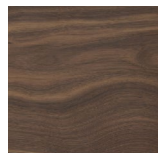

NOCE CANALETTA
Canaletta Walnut

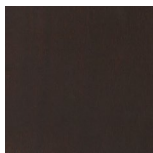

NOCE CANALETTA
Canaletta Walnut
tinto/stained moka



NOCE CANALETTA
Canaletta Walnut
tinto/stained wengé

Laccato opaco poro aperto/chiuso | Matt Lacquered open/closed pore

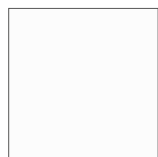

BIANCO
White
(RAL 9016)



AVORIO
Ivory
(RAL 1013)



ARGILLA
Argilla
(RAL 7006)



PIOMBO
Piombo
(NCS S5005G20Y)



NERO
Black
(RAL 9005)



GRANATA
Granata
(NCS S4050Y90R)



PISTACCHIO
Pistacchio
(PANTONE 5825)

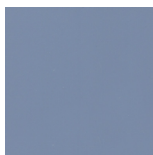

AVIO
Avio
(PANTONE 5415)

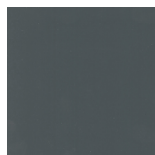

IRON
Iron
(RAL 7011)



CIOCCOLATO
Chocolate
(RAL 8019)

Pelle | Leather

Cat. LUX

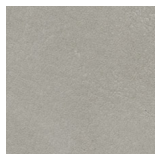

Nabuk

Cat. PLUS



Pelle PLUS

Cat. EXTRA

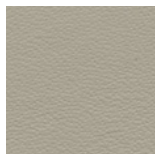

Pelle EXTRA

Cat. PELLE

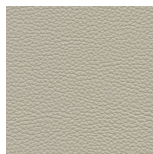

Pelle

Rivestimento | Cover

Cat. A

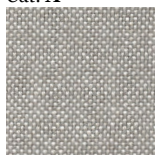

Hallingdal 65



Hound

Cat. B

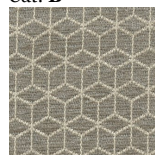

Rabat



Milord

Cat. C



Armam



Fashion



Flax



Ikat



Loom

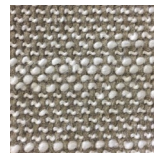

Madras



Moran

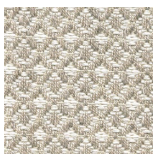

Thalys

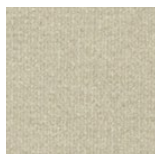

Velvet

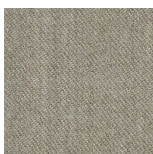

Wool

Cat. D

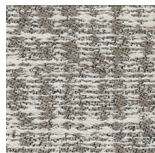

Astra

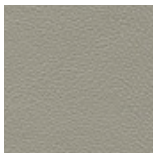

Ecopelle

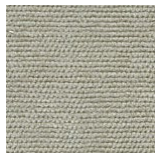

Range



Tress

Cat. E



Cotone



Dorian



In Bianco/Calico

Cat. COM

Disponibile con tessuto fornito dal cliente.

Available with fabric supplied by the customer.

Verfügbar mit Kundenstoff.

Disponible avec tissu du client.

Disponible con tela suministrada por el cliente.