

# Es.

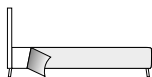







## Letto imbottito con giroletto H. 10 / 25

*Upholstered bed with bed frame H. 10 / 25*



**Sfoderabile**  
*Removable cover*



		W	M	T	F	U	V	L	Z	H
		 Bianco	 Madreperla	 Tortora	 Fumo	 Noce canaletto	 Termocotto	 Alluminio lucido	 Grafite	 Black nichel
H. 10	<b>PIE88 *</b> Tondo inclinato H. 24	•	•	•	•	•	•			
	<b>PIEMAX_Z</b> Pedana H. 18								•	
H. 25	<b>PIE38</b> Tondo inclinato H. 10	•	•	•	•	•	•			
	<b>PIE41</b> Squadrato inclinato H. 10							•	•	

\* Utile H. 18 con rete strutturale  
*Utile H. 18 con rete strutturale*

# ès. H10

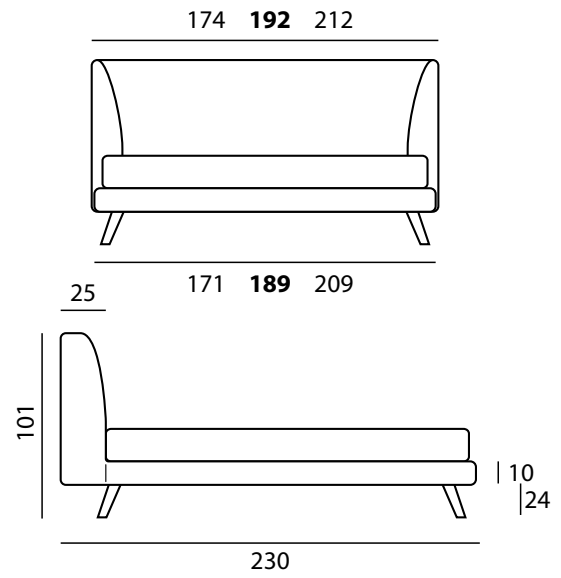

# ès. H25

