



Maarten Table

BY VÍCTOR CARRASCO

Maarten Table

BY VÍCTOR CARRASCO

Technical Info EN

2014



Table system is based on a technical minimalist leg solution that does not need a structure and can be attached directly to the table top.

Having no structure and a table top thickness of just 5 mm it acquires great visual lightness. There are endless uses, finishes and formats with this innovative system.

Its "one mile" concept expresses how it can be used for breakfast in the kitchen, then working in the office, for eating in its restaurant version and later on for a meeting around it as a boardroom table and finally for dinner in the evening.

Víctor Carrasco

Born in Valencia (Spain) in 1974, Víctor Carrasco began his professional career after graduating Cum Laude in Industrial Design Engineering at the Polytechnic University of Valencia.

Shying away from trends and fads, he has developed and positioned international brands with remarkable added value, thanks to his passion for synthesis, sustainable growth and his pragmatic vision of the future.

Since 2007, he has been combining his position as strategic director of Viccarbe with that of Director Business Development for the prestigious American multinational Coalesse (Steelcase Inc.). Likewise, as an industrial designer, he has collaborated with numerous international companies.

He was the recipient of the Prince Felipe Award for Business Excellence and he has also won the German Design Award.



HEIGHT 74 | 29¹³/₆₄

MAA80_
table 80x80 | 31¹/₂ x 31¹/₂

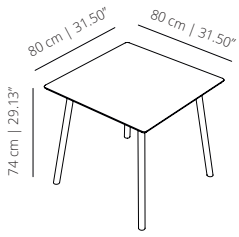

MAA160_
table 160x80 | 31¹/₂ x 62⁶³/₆₄

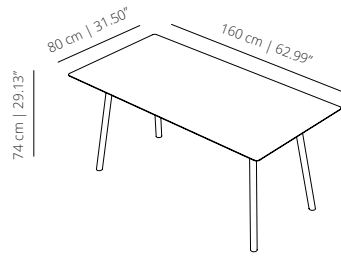

HEIGHT 74 | 29¹³/₆₄

MAA160_
table 160x90 | 35⁷/₁₆ x 62⁶³/₆₄

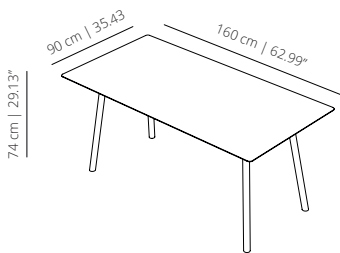

MAA180_
table 180x80 | 70⁵⁵/₆₄ x 31¹/₂

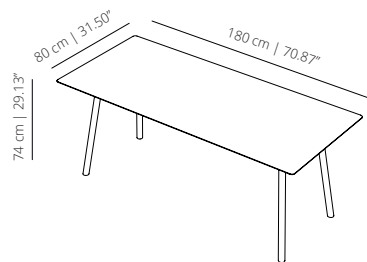

HEIGHT 74 | 29¹³/₆₄

MAA180_
table 180x90 | 35⁷/₁₆ x 62⁶³/₆₄

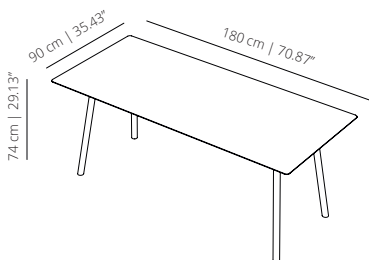

MAA200_
table 200x80 | 31¹/₂ x 78⁴⁷/₆₄

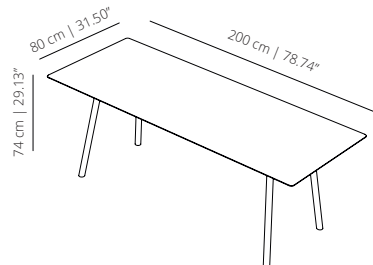

HEIGHT 74 | 29¹³/₆₄

MAA200_
table 200x80 | 35⁷/₁₆ x 78⁴⁷/₆₄

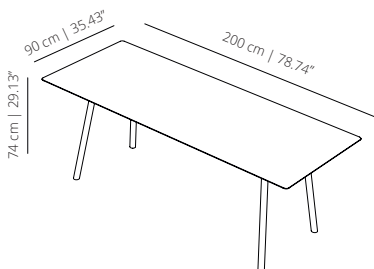

MAAD120_
table 120 | 47¹/₄

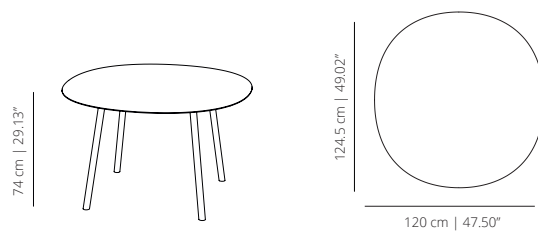

HEIGHT 74 | 29⁹/₆₄"

MAAD160_
table 160 | 62⁶³/₆₄"

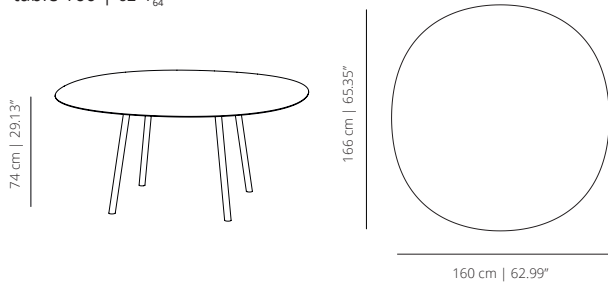

MAAA180_
table 180x80 | 70⁵⁵/₆₄" x 31¹/₂" return table

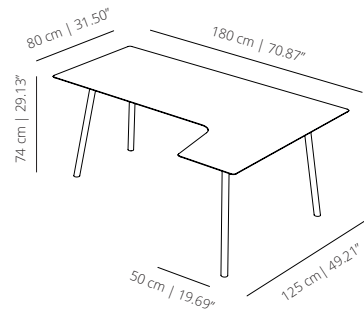

HEIGHT 74 | 29⁹/₆₄"

MAA80_
table 80x80 | 31¹/₂" x 31¹/₂" with casters

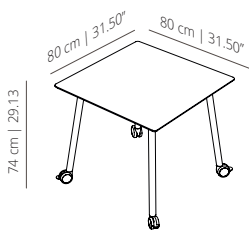

MAA160_
table 160x80 | 31¹/₂" x 62⁶³/₆₄" with casters

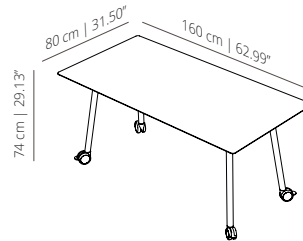

HEIGHT 74 | 29⁹/₆₄"

MAA160_
table 160x90 | 35⁷/₁₆" x 62⁶³/₆₄" with casters

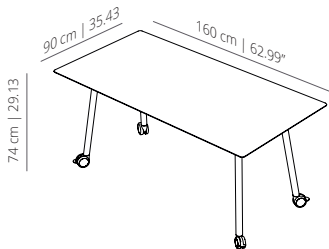

MAA180_
table 180x80 | 70⁵⁵/₆₄" x 31¹/₂" with casters

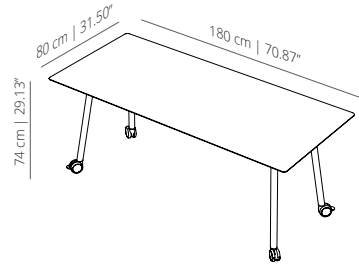

HEIGHT 74 | 29⁹/₆₄"

MAA180_
table 180x90 | 35⁷/₁₆" x 62⁶³/₆₄" with casters

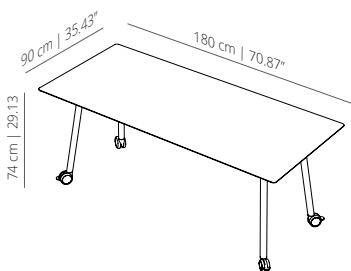

MAA200_
table 200x80 | 31¹/₂" x 78⁴⁷/₆₄" with casters

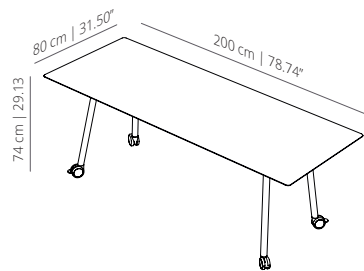

MAA200_
table 200x90 | 35⁷/₁₆ x 78⁴⁷/₆₄ with casters

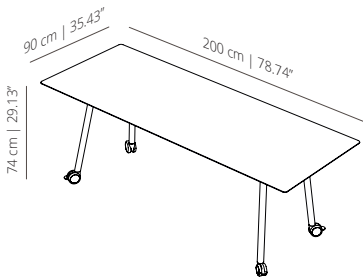

MAAA180_
table 120 | 47¹/₄ with casters

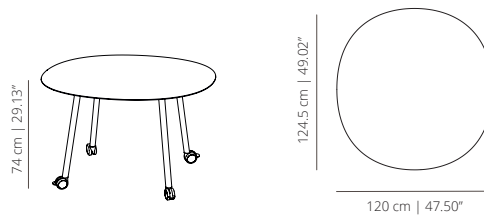

MAAD160_
table 160 | 62⁶³/₆₄ with casters

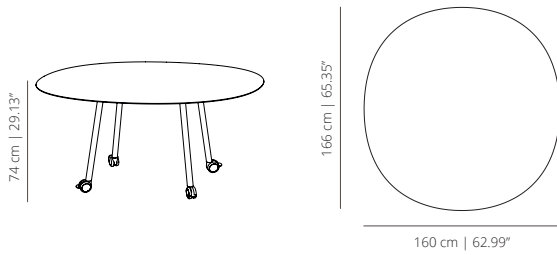

MAAA180_
table 180x80 | 70⁵⁵/₆₄ x 31¹/₂ return table with casters

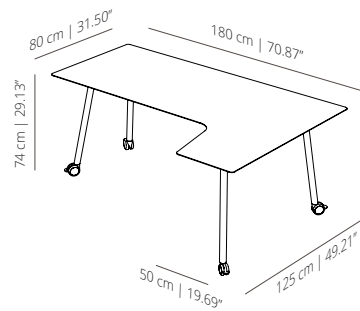

ACCESSORIES

CARB

storage unit 2 drawers + filling cabinet

For folders, larger than DIN-4, some accessories are required. Not included.

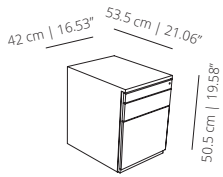

CAJB

storage unit 4 drawer

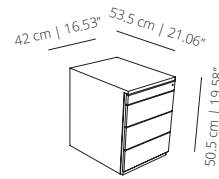

AC03B

wire hole

Cut out of the board is included.

Dimensions: Ø 6 cm | 2.36"



TRMEC

cut out

Table top with incision to measure. The price is indicated per table top.

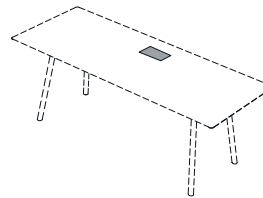

TRPROT

table top protector in eco leather

Dimension: 44x90 cm | 17.3"x35.4"

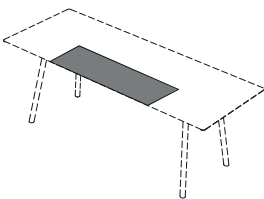

LECAN

wire holder

Dimension: 99x16x9 cm | 38.97"x6.29"x 3.54"



LEWIRES

simple wire column

Dimension: 25x12x71cm | 9.8"x4.7"x27.9"

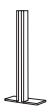

LEWIRED

double wire column

Dimension: 25x12x71cm | 9.8"x4.7"x27.9"

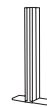

ACCESSORIES

MAAF160_ modesty screen 160

Dimensions: 114x33 cm | 444.6"x128.7"

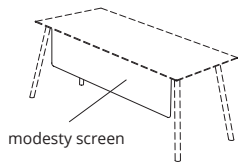

MAAF180_ modesty screen 180 and 200

Dimensions: 134x33 cm | 522.6"x128.7"

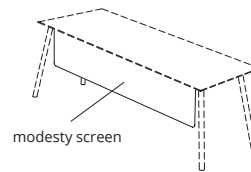

For the different table tops, we offer the possibility of installing the following accessories. The drawings with the location of the accessories need the approval of the technical department.

CAP* rectangular conduit

Metallic access cover to the lower part of the table. Available in white, black or grey. Does not include electrifications. Dimensions: 32x15 cm | 12.59"x5.90"

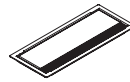

**Cut out not included*

CAPP* rectangular conduit plus

Metal access cover to the lower part of the table, for wooden table tops. Metal frame available in black or grey and central part in the veneer of the finish of the table. Does not include electrifications. Dimensions: 32x15 cm | 12.59"x5.90"



**Cut out not included*

MAAUSB USB port

USB port for charging electronic devices totally integrated in the bench. Available in white or black. Dimensions: Ø 3 cm | 1.18"



MAAWI wireless charger

Concealed wireless charger that is compatible with all devices with Qi version 1.2 wireless charging system. It has a quick charge system.

NOTE: The wire hole is included if it coincides with the center of the base column. It is not included for other positions.



BOX-E* | BOX-M* power box for table top

BOX-E: 4 plugs | BOX-M: 4 elements (plugs and multimedia) elements. Available in white, black or grey. Dimensions: 32x15 cm | 12.59"x5.90".

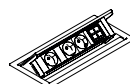

**Cut out not included*

ACCESSORIES

BOXP-E* | BOXP-M*

power box plus for table top

BOXP-E: 4 plugs | BOXP-M: 4 elements (plugs and multimedia).
Metal cover with 4 plugs or combined with integrated multimedia elements, for wooden table tops. Metal frame available in black or grey and central part in the veneer of the finish of the table. Dimensions: 32x15 cm | 12.59"x5.90".

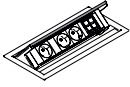

*Cut out not included

CUBO

table top protector in eco leather

Power box available with 2 plugs or combined with integrated multimedia elements. Metal frame available in white or black.



NOTE: Not available for compact.

Legs adjustable in height:

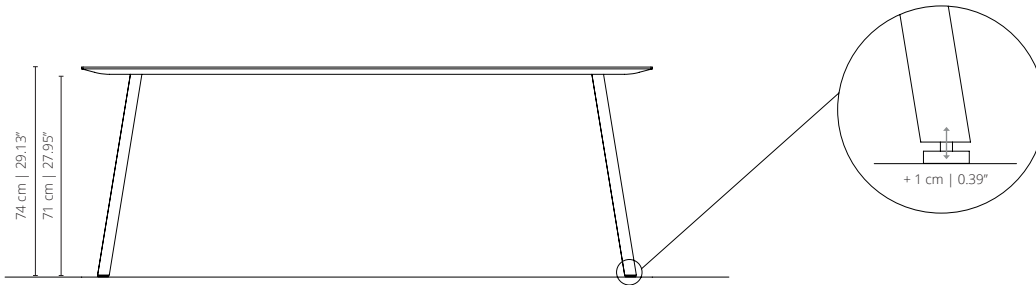

Thickness and type of table top edge:

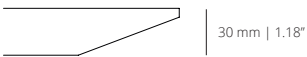

FINISHES

LEGS

Powder coated



white
RAL 9003



black
RAL 9005



altea blue
RAL 5000



sand
RAL 1019



fluor orange
NCS 3005Y50R

Stained



matt oak



cognac



wenge



ash

TABLE TOP

Lacquered



white
RAL 9003



black
RAL 9005



blue
RAL 5024



tobacco
RAL 8028



smoke
RAL 1019



grey
RAL 7004



red
RAL 9001



silver
RAL 9006



mustard
RAL 1012



green
RAL 6007



bronze



sand
NCS 3005Y50R

Stained



matt oak



cognac



wenge



ash

HPL with MDF



black



white

TECHNICAL INFO

Maarten is a collection of tables and complements that allows many compositions and finishes.

The 30 mm thick cover or work surface is made with microtextured MDF. It is lacquered with one of our collection's finishes, making it very scratch resistant. It also comes with a solid oak veneer, stained in mate, wenge, cognac or ash. Available in high resistance materials such as HPL with MDF for heavy contract use.

The legs are made from calibrated steel, powder coated in thermoreinforced polyester. Available in white, black, fluorescent orange, altea blue or a stained oak veneer with the finishes of our collection.

NOTE: Due to the fact that the wood used is natural, the finish may vary.

CERTIFICATIONS

UNE EN 527-1:11, UNE EN 527-2-3:03 and ANSI/BIFMA X5.5:2014 (table height 74).



viccarbe